

Parte esterna termostatico doccia incasso 3 uscite CUBIC_CU018200

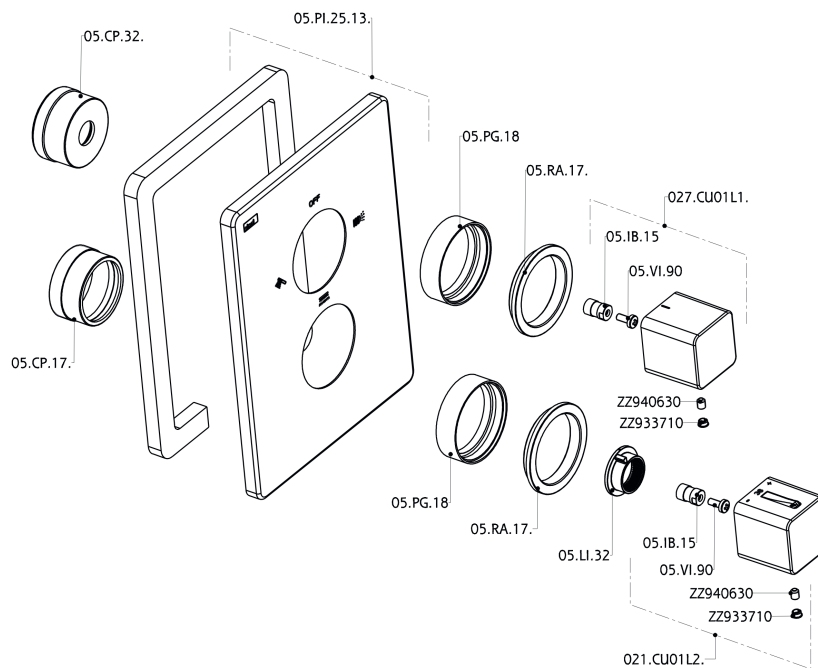

CU018200

<https://www.cisal.it/parte-esterna-termostatico-doccia-incasso-3-uscite-cubic-cu018200>

Parte incasso termostatico doccia 3 uscite INCASSO_ZA018201

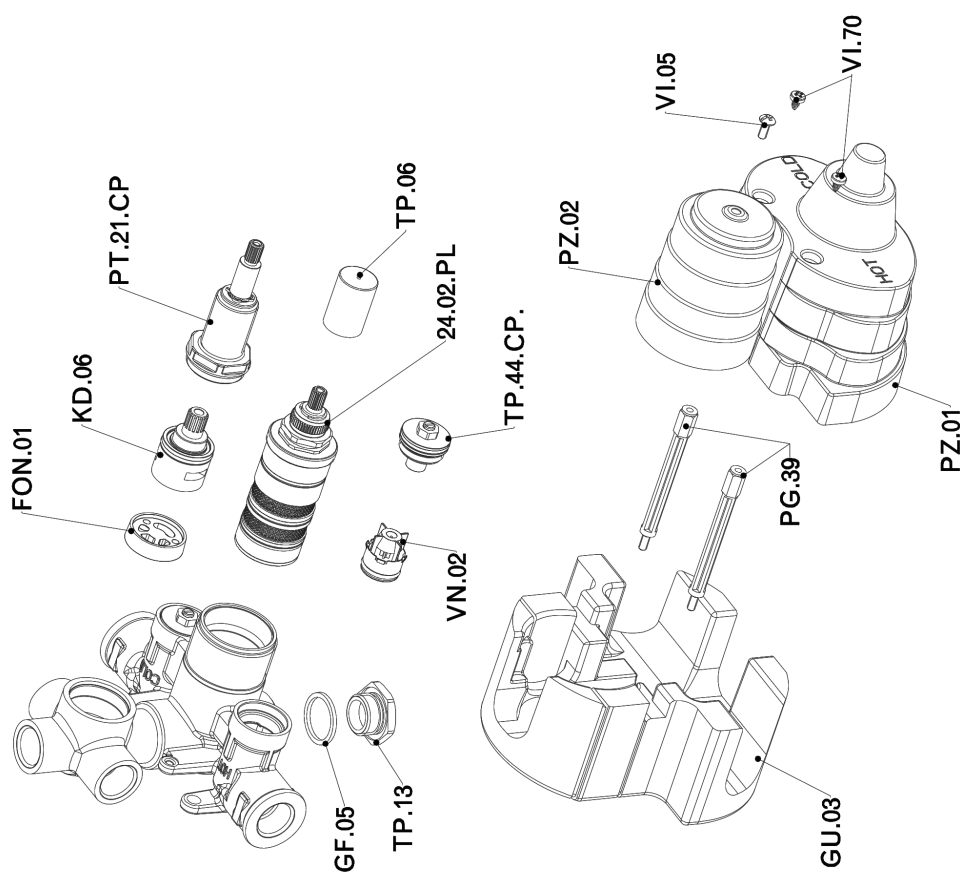

ZA018201

<https://www.cisal.it/parte-incasso-termostatico-doccia-3-uscite-incasso-za018201>

2026-05-09