

Parte esterna termo doccia incasso 3 funzioni CUBIC_CU01R300

CU01R300

<https://www.cisal.it/parte-esterna-termo-doccia-incasso-3-funzioni-cubic-cu01r300>

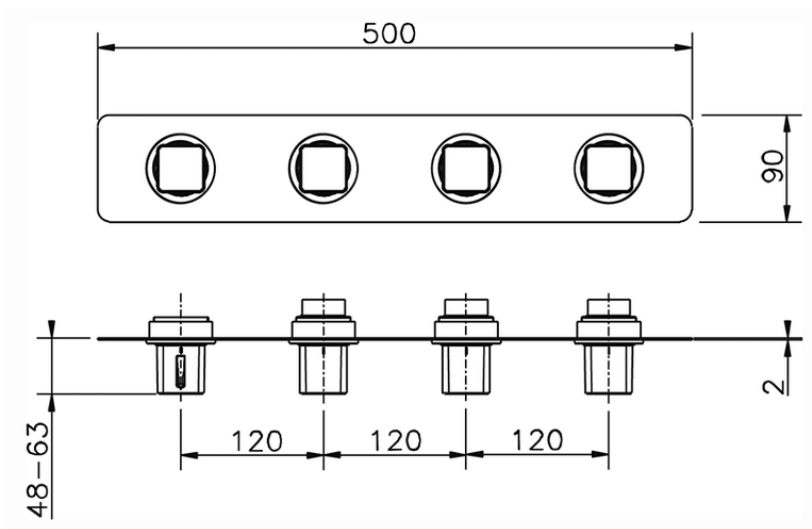

ZA01R300

<https://www.cisal.it/parte-incasso-termostatico-3-funzioni-incasso-za01r300>

2026-06-18