

Miscelatore termostatico vasca con saliscendi GRACE_MNS21016

MODELLO **MNS21016**

Miscelatore termostatico vasca con saliscendi, asta saliscendi 60 cm con supporto scorrevole, doccia monogetto D.22,5 mm in Ottone, flessibile liscio SUPREME 150 cm

FINITURE DISPONIBILI

-  **21** 21 Cromo
-  **2F** 2F Nichel Spazzolato
-  **2W** 2W Oro Spazzolato
-  **5H** 5H Dark Brass Brushed
-  **5L** 5L Black Titanium Spazzolato
-  **6T** 6T Cromo/Nero Opaco

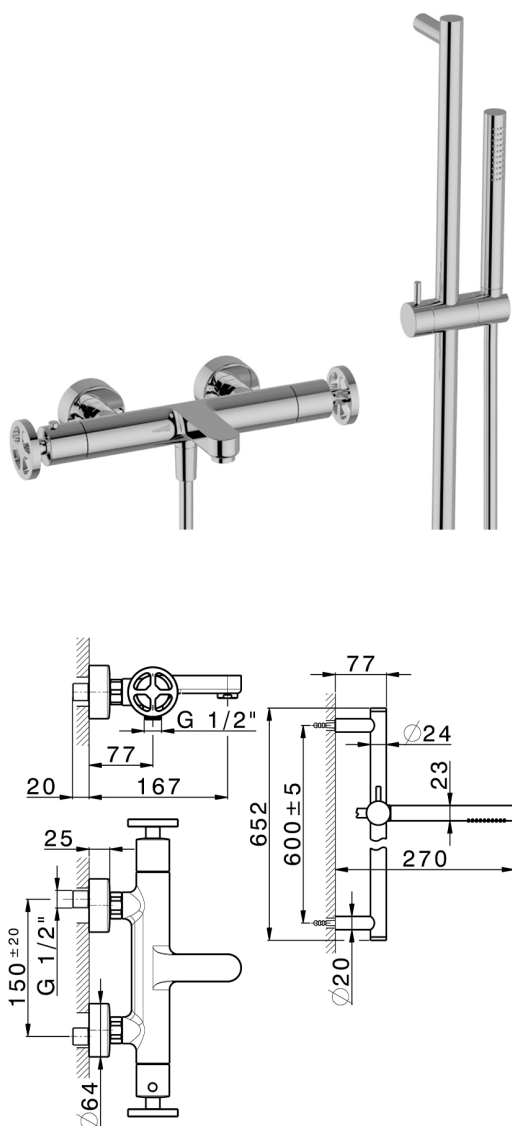

CARATTERISTICHE

Ricambio Cartuccia **22.04A.AR - ZZ97279004**

Cartuccia Termostatica Argo 2 (filtro lungo)



DeviaStop

La tecnologia Devia Stop di Cisal consente con un semplice movimento rotativo di gestire la portata dell'acqua e di scegliere la modalità d'erogazione (soffione, doccia a mano).



Termostatico

Il Termostatico Cisal è il tuo personale gestore dell'acqua che ti aiuta a gestire e controllare acqua ed energia senza sprechi.



2026-04-18