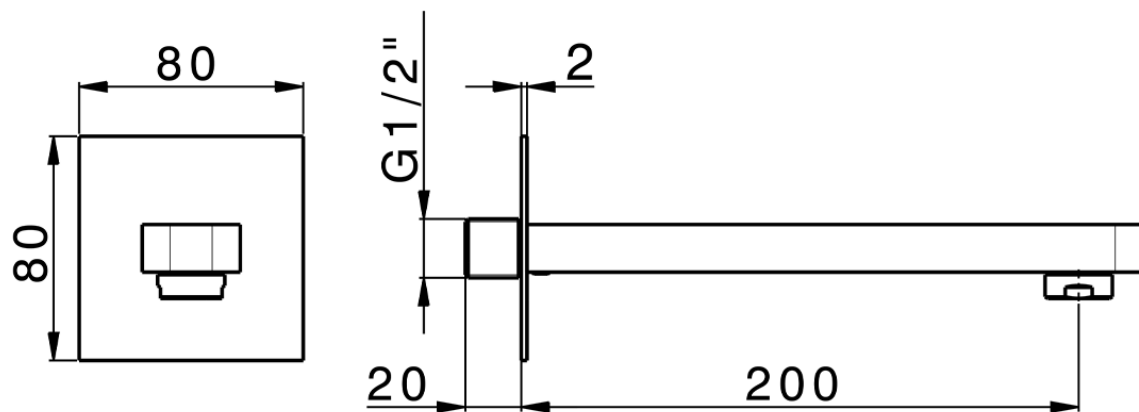

Bocca di erogazione PUSH&SHOWER_ZA0G5120

ZA0G5120

<https://www.cisal.it/bocca-di-erogazione-pushshower-za0g5120>

2026-04-14