

Colonna miscelatore doccia 2 funzioni ARCANA CERAMIC_AC004051

MODELLO **AC004051**

Colonna miscelatore doccia 2 funzioni,deviatore 2 uscite,colonna telescopica,con supporto doccetta fisso,doccetta monogetto Arcana D.53 mm,soffione tondo D.210 mm in Ottone,flex PVC 150 cm

FINITURE DISPONIBILI

-  **21** 21 Cromo
-  **24** 24 Oro
-  **26** 26 Vecchio Rame
-  **27** 27 Vecchio Bronzo
-  **2A** 2A Nichel Satinato Spazzolato
-  **74** 74 Cromo/Oro

CARATTERISTICHE

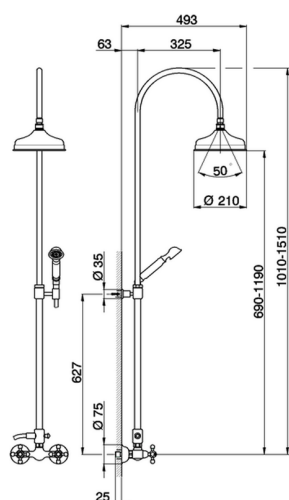

Colonna miscelatore doccia 2 funzioni ARCANA CERAMIC_AC004051

cisal

AC 00405 1

da Febbraio 2009 - from February 2009
ab Februar 2009 - de Février 2009

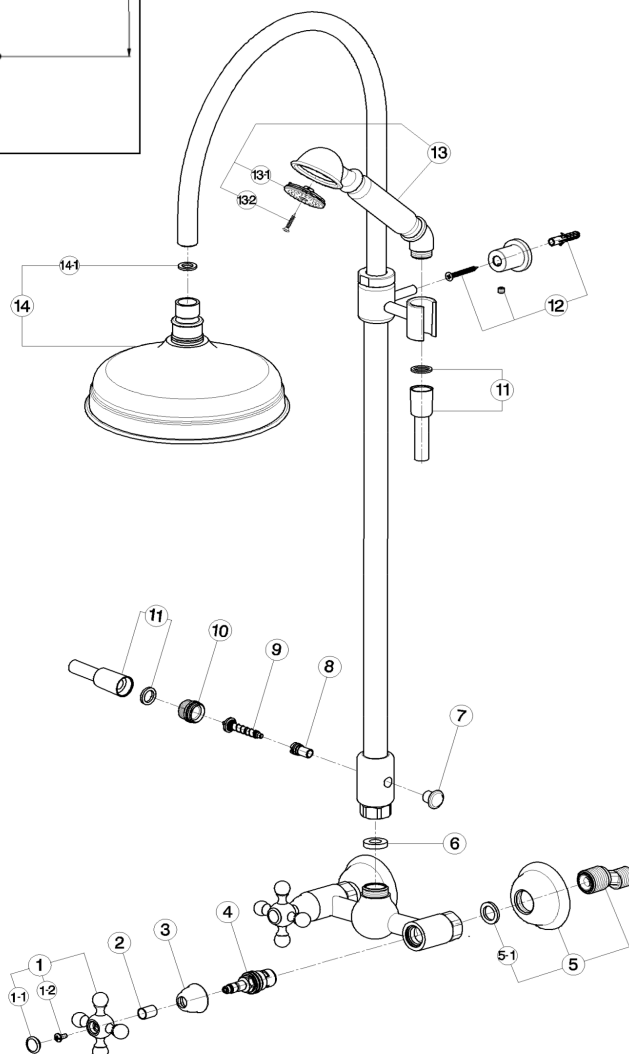
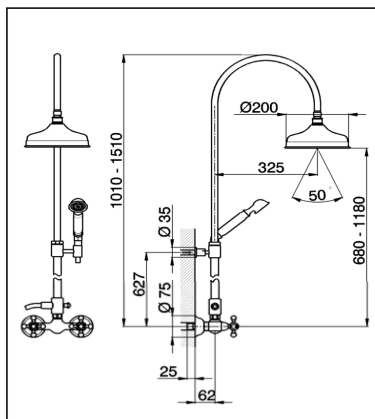

AC004051

<https://www.cisal.it/colonna-miscelatore-doccia-2-funzioni-arcana-ceramic-ac004051>

Colonna miscelatore doccia 2 funzioni ARCANA CERAMIC_AC004051

cisal

AC 00405 1

 da Febbraio 2009 - from February 2009
 ab Februar 2009 - de Février 2009

NR.	DESCRIZIONE DESCRIPTION BESCREIBUNG DESCRIPTION	N.CODICE CODE NO. WERSKNR. NR.CODE	NR.	DESCRIZIONE DESCRIPTION BESCREIBUNG DESCRIPTION	N.CODICE CODE NO. WERSKNR. NR.CODE	NR.	DESCRIZIONE DESCRIPTION BESCREIBUNG DESCRIPTION	N.CODICE CODE NO. WERSKNR. NR.CODE
1	Maniglia AR con vite e placchetta Croisillon AR avec vis et plaque Handle AR Griff AR mit Schraube Placchetta a vite maniglia AR	ZZ903070	6	Guarnizione NBR 90 SH. 24x16x2,7 Joint NBR 90 SH. 24x16x2,7 Gasket NBR 90 SH. 24x16x2,7 Dichtung NBR 90 SH. 24x16x2,7	ZZ926890	13-1	Diffusore doccia AR Aérateur douche AR Aerator for showers AR Zerstäuber fuer Brause AR	ZZ905440
1-1	Plaque cache vis croisillon AR Cap for handle AR Abdeckkappe AR Griff	ZZ926170	7	Pomolo per deviazione Pommeau pour inverseur Knob for diverter Zugknopf Umsteller	ZZ933940	13-2	Vite di fissaggio diffusore per doccia Vis de fixation diffuseur pour douche Fixing screw for spray kit handshower Befestigungsschraube fuer Einsatz	ZZ934010
1-2	Vite M.4,5x10 tb.tc zigrinata Vis M.4,5x10 Schraube M.4,5x10	ZZ926090	8	Corpo deviazione automatica Corps inverseur automatique Body for automatic diverter Körper für automatische Umstellung	ZZ949860	14	Soffione doccia Pomme de douche Headshower Kopfbrause	DS016140
2	Tubetto copriasta AR H.15,5 Tube couvre tete AR H.15,5 Sliding cover tube "AR" Abdeckkappe Oberteil AR H.15,5	ZZ926190	9	Asta deviazione completa Tige inverseur complète Complete diverting rod Umstellung	ZZ933140	14-1	Guarnizione fibra 18,5x11x2 Joint en fibre 18,5x11x2 Gasket rubber 18,5x11x2 Fiberdichtung 18,5x11x2	ZZ927140
3	Cappuccio coprivite Ø32 H.21 AC Rosace couvre tete Ø32 H.21 AC Escutcheon Ø32 H.21 AC headvalve Abdeckkappe Ø32 H.21 AC	ZZ926520	10	Guarnizione 18,8 X12X3 con filtro Joint.18,8X3 avec filtre Gasket 18,8X3 with filter Dichtung 18,8X3 mit filter	ZZ931410			
4	Vitone cer. DX per monof. e gruppi AC Tete ceramique 1/2" droite AC Courte Ceramic headvalve 1/2" right AC short Keramikoberteil 1/2" rechts AC kurz	ZZ928580	11	Flessibile D.14x150 1/2" conico x 1/2" Flexible D.14x150 avec raccord 1/2" Hose D.14x150 1/2"x1/2" Schlauch D.14x150 1/2" Konus x 1/2"	ZA009030			
5	Eccentrico con rosone "AC" Excentrique + rosace "AC" Excentric connect. with escutch. "AC" S - Anschluss m.Rosette "AC"	ZZ928260	12	Set installazione asta doccia Set installation colonne de douche Installation set for sliding bar Installationsset für Wandstange	ZZ949870			
5-1	Guarnizione NBR 90 SH. 24x16x2,7 Joint NBR 90 SH. 24x16x2,7 Gasket NBR 90 SH. 24x16x2,7 Dichtung NBR 90 SH. 24x16x2,7	ZZ926890	13	Doccia Arcana Douchette Arcana Arcana handshower Handbrause Arcana	DS014110			

AC004051

<https://www.cisal.it/colonna-miscelatore-doccia-2-funzioni-arcana-ceramic-ac004051>

2026-05-05