

## Parte esterna termostatico doccia incasso 3 uscite LESS MINIMAL\_LN018200

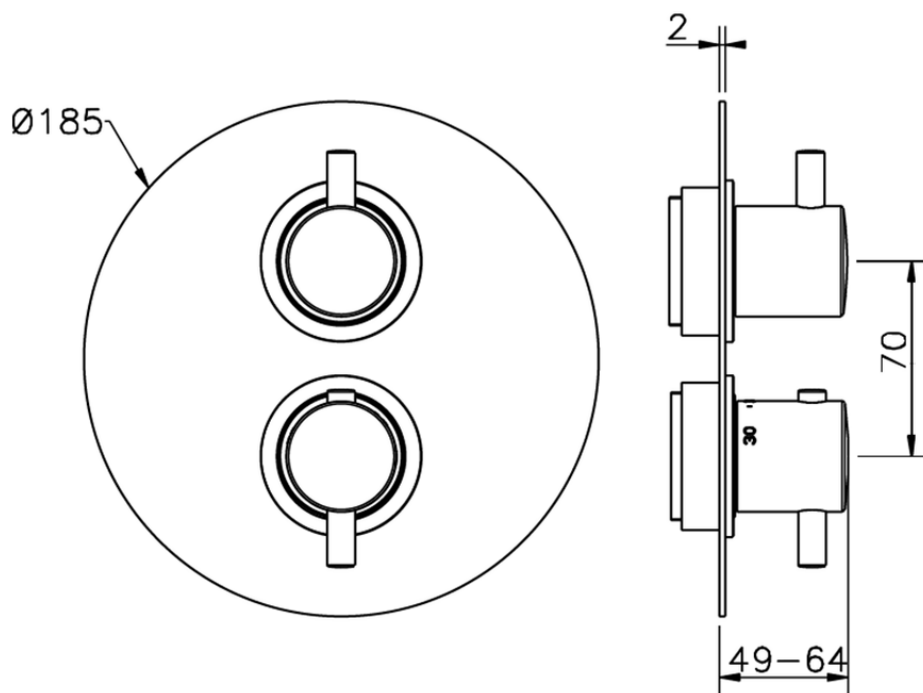

LN018200

<https://www.cisal.it/parte-esterna-termostatico-doccia-incasso-3-uscite-less-minimal-ln018200>



Piastra/Plate/Plaque/Platte/Placa

2-3mm: XX 25-40 YY 76-91

10 mm: XX 16-31 YY 65-80

ZA018201

<https://www.cisal.it/parte-incasso-termostatico-doccia-3-uscite-incasso-za018201>

2026-06-20