

## Parte esterna termo doccia incasso 3 funzioni WELLNESS\_RI01V300

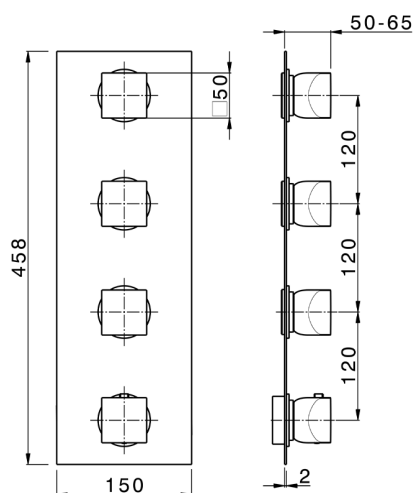

MODELLO **RI01V300**

Parte esterna termo doccia incasso 3 funzioni, per art. ZA01V300

### FINITURE DISPONIBILI

-  **21** 21 Cromo
-  **24** 24 Oro
-  **2F** 2F Nichel Spazzolato
-  **2W** 2W Oro Spazzolato
-  **40** 40 Nero Opaco
-  **4Q** 4Q Bianco Opaco
-  **5G** 5G Oro Rosa
-  **6V** 6V Bianco Opaco/Nichel Spazzolato
-  **6X** 6X Bianco Opaco/Oro Spazzolato
-  **7W** 7W Nero Opaco/Oro Spazzolato



### Termostatico

Il Termostatico Cisal è il tuo personale gestore dell'acqua che ti aiuta a gestire e controllare acqua ed energia senza sprechi.

### CARATTERISTICHE

Installazione **Incasso**  
Parti Incasso necessarie **ZA01V300**



## Parte incasso termostatico 3 funzioni INCASSO\_ZA01V300

MODELLO **ZA01V300**

Parte incasso termostatico 3 funzioni

FINITURE DISPONIBILI



CARATTERISTICHE

Ricambio Cartuccia **23.51A.HF**

Incasso **1**

**Cartuccia Termostatica HF**



### Termostatico

Il Termostatico Cisal è il tuo personale gestore dell'acqua che ti aiuta a gestire e controllare acqua ed energia senza sprechi.



2026-06-25