

Parte esterna termo doccia incasso 2 funzioni SLIM_SM01R200

SM01R200

<https://www.cisal.it/parte-esterna-termo-doccia-incasso-2-funzioni-slim-sm01r200>

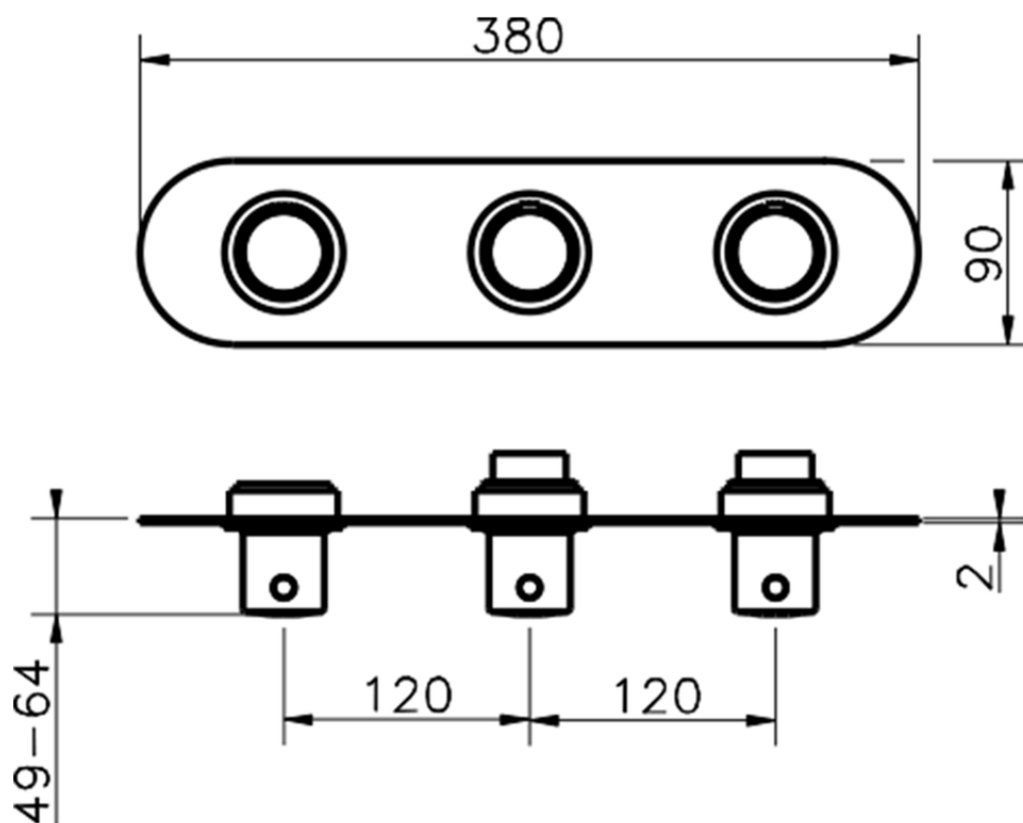
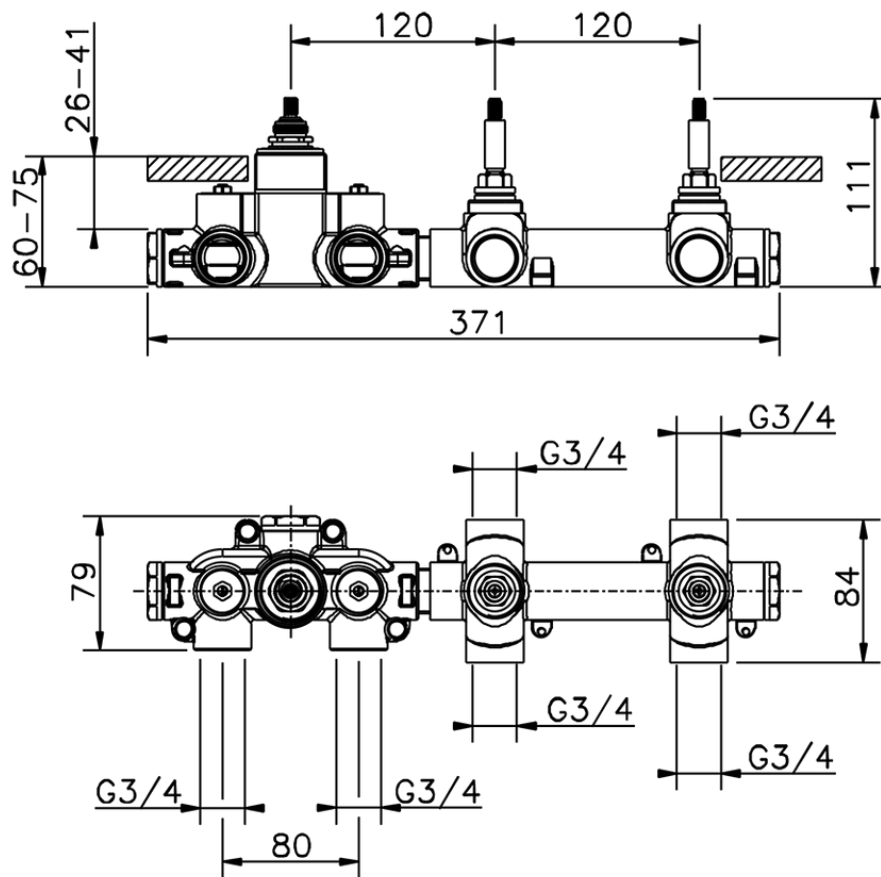

ZA01R200

<https://www.cisal.it/parte-incasso-termostatico-2-funzioni-incasso-za01r200>

2026-07-09