

Parte esterna termostatico incasso PUSH&SHOWER_PS1G1020

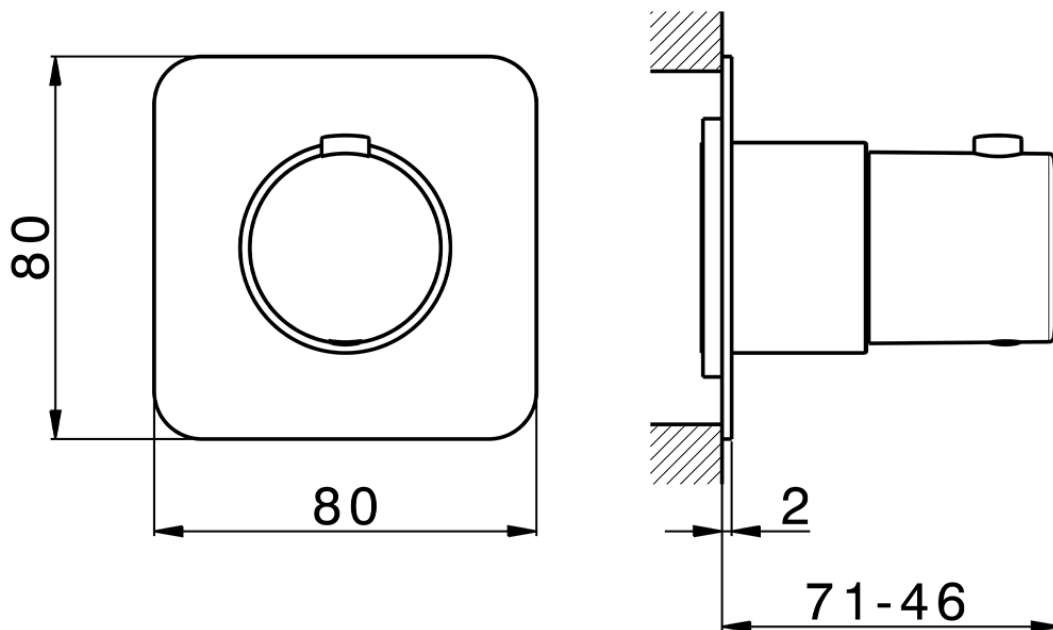

PS1G1020

<https://www.cisal.it/parte-esterna-termostatico-incasso-pushshower-ps1g1020>

2026-06-13