





## Parte esterna termostatico doccia incasso SLIM\_SM007200



MODELLO **SM007200**

Parte esterna termostatico doccia incasso, senza rubinetto d'arresto, senza parte incasso, per art. ZA007220

### FINITURE DISPONIBILI

-  **21** 21 Cromo
-  **2B** 2B Nichel Lucido
-  **40** 40 Nero Opaco
-  **4Q** 4Q Bianco Opaco

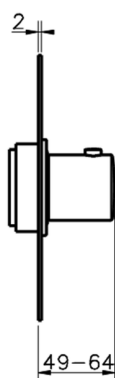
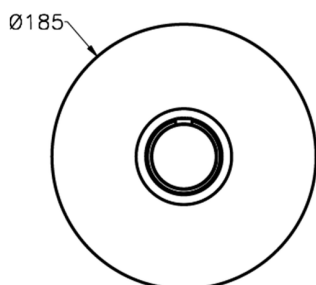

### CARATTERISTICHE

Installazione **Incasso**  
Parti Incasso necessarie **ZA007220**



### Termostatico

Il Termostatico Cisal è il tuo personale gestore dell'acqua che ti aiuta a gestire e controllare acqua ed energia senza sprechi.



## Parte incasso termostatico 3/4" INCASSO\_ZA007220

MODELLO **ZA007220**

Parte incasso termostatico 3/4", senza rubinetto d'arresto, senza parte esterna

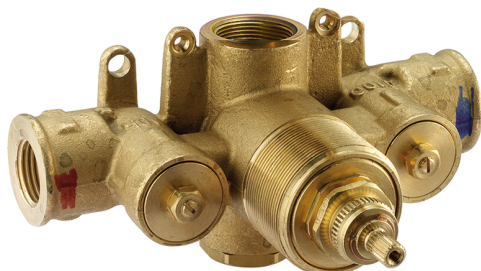

FINITURE DISPONIBILI



**04** 04 Senza Finitura

CARATTERISTICHE

Ricambio Cartuccia **23.51A.HF**

Incasso **1**

**Cartuccia Termostatica HF**

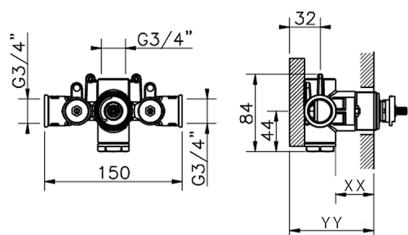

Piastra/Plate/Plaque/Platte/Placa

2-3mm: XX 25-40 YY 76-91

10mm: XX 16-31 YY 65-80



### Termostatico

Il Termostatico Cisal è il tuo personale gestore dell'acqua che ti aiuta a gestire e controllare acqua ed energia senza sprechi.



2026-05-03