

Parte esterna termostatico doccia incasso CUBIC_CU007200

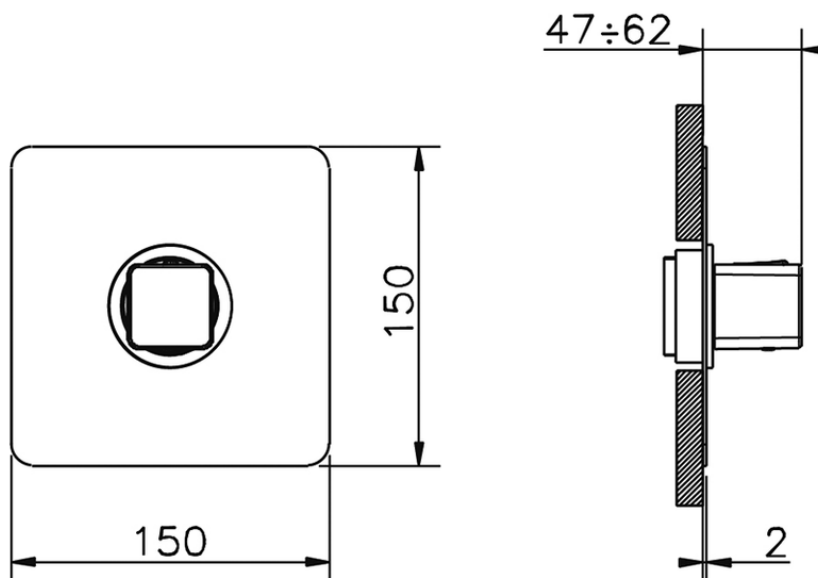

CU007200

<https://www.cisal.it/parte-esterna-termostatico-doccia-incasso-cubic-cu007200>



Piastra/Plate/Plaque/Platte/Placa

2-3mm: XX 25-40 YY 76-91

10mm: XX 16-31 YY 65-80

ZA007221

<https://www.cisal.it/parte-incasso-termostatico-3-4-incasso-za007221>

2026-07-02