

Parte esterna termo doccia incasso 2 funzioni HI-RISE_RI01R200

RI01R200

<https://www.cisal.it/parte-esterna-termo-doccia-incasso-2-funzioni-hi-rise-ri01r200>

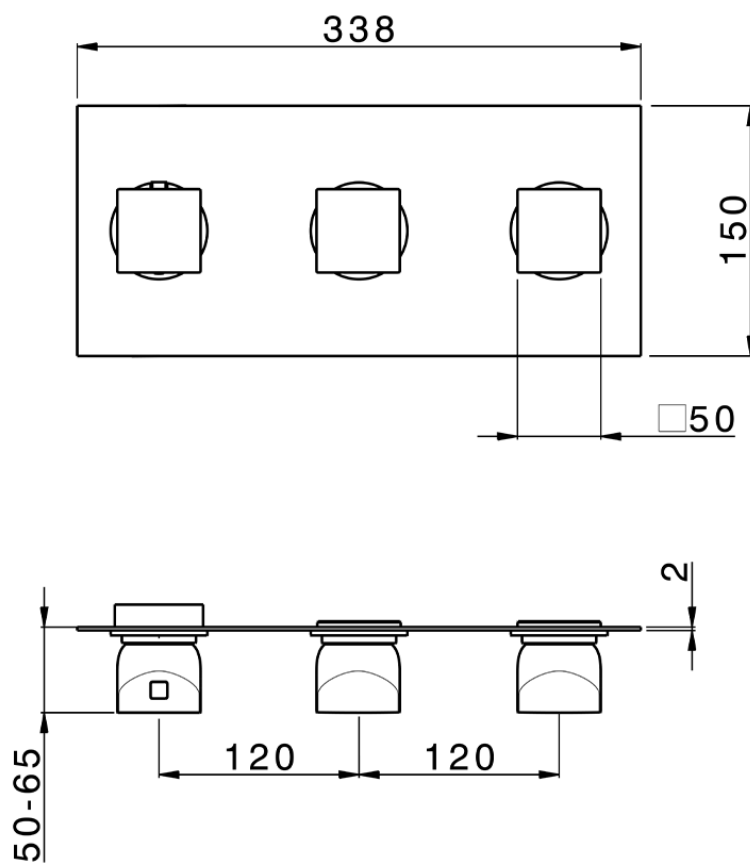

ZA01R200

<https://www.cisal.it/parte-incasso-termostatico-2-funzioni-incasso-za01r200>

2026-05-11