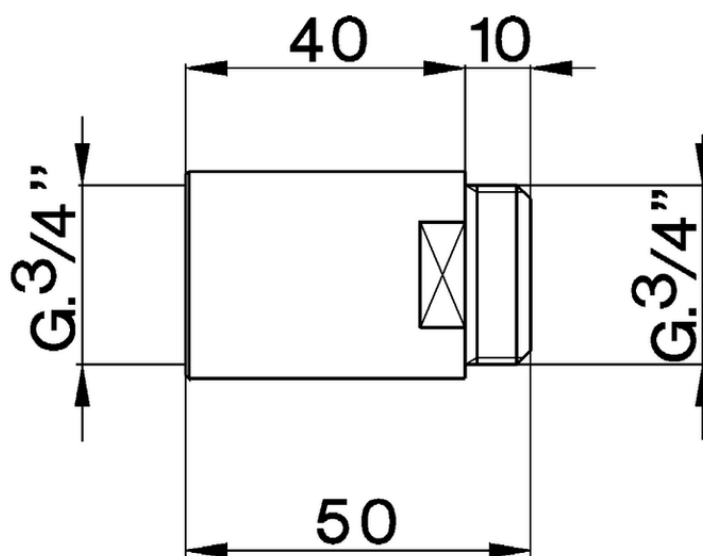

Prolunga COMPLEMENTI_ZA003770

ZA003770

<https://www.cisal.it/prolunga-complementi-za003770>

2026-04-04