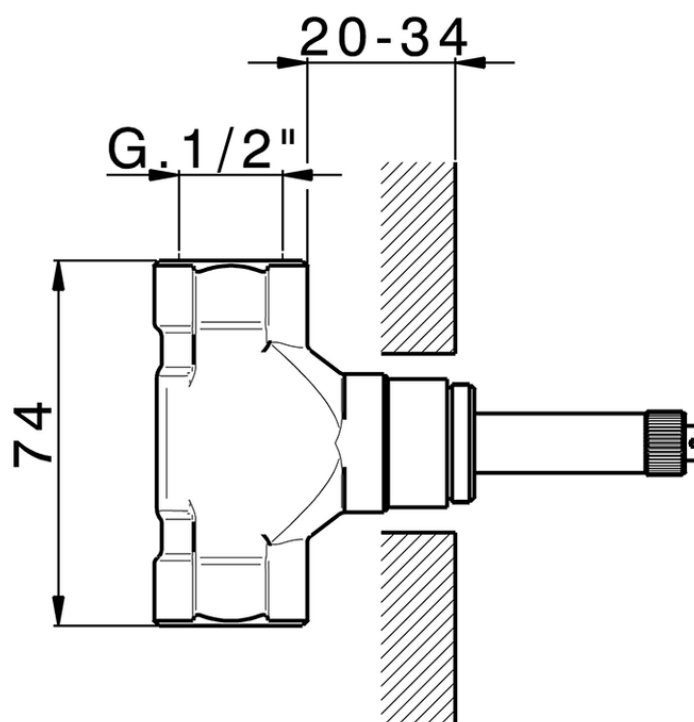

**Parte incasso rubinetto 1/2" INCASSO\_ZA003321**

ZA003321

<https://www.cisal.it/parte-incasso-rubinetto-1-2-incasso-za003321>

2026-07-06