

Parte incasso rubinetto 1/2" INCASSO_ZA003321

MODELLO **ZA003321**

Parte incasso rubinetto 1/2", apertura in senso orario

FINITURE DISPONIBILI

 **04** 04 Senza Finitura

CARATTERISTICHE

Incasso **1**

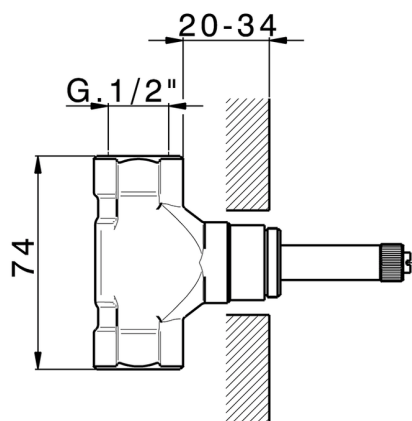

2026-07-06