

Parte esterna lavabo a parete HI-RISE_RM013511

MODELLO **RM013511**

Parte esterna lavabo a parete, senza parte incasso, per art. ZA033510, con maniglie marmo

FINITURE DISPONIBILI



7S 7S Marmo Bianco Carrara/Oro Spazzolato



7X 7X Marmo Bianco Carrara/Nichel Spazzolato



7Y 7Y Marmo Bianco Carrara/Cromo



8A 8A Marmo Nero Marquinia/Oro Spazzolato



8B 8B Marmo Nero Marquinia/Oro



8D 8D Marmo Nero Marquinia/Cromo

CARATTERISTICHE

Installazione **Incasso**

Parti Incasso necessarie **ZA033510**



Parte incasso lavabo a parete INCASSO_ZA033510

MODELLO **ZA033510**

Parte incasso lavabo a parete, con due vitoni destri

FINITURE DISPONIBILI



CARATTERISTICHE

Incasso **1**

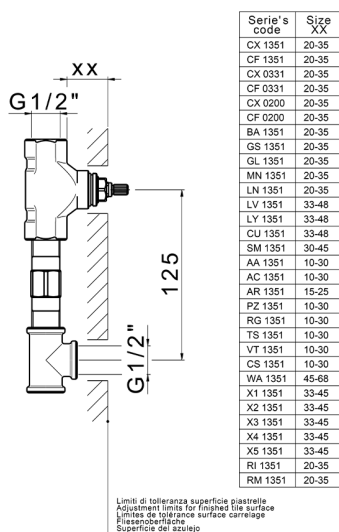

2026-05-16