

## Parte esterna termo doccia incasso 2 funzioni WELLNESS\_X300R200

MODELLO **X300R200**

Parte esterna termo doccia incasso 2 funzioni, per art.ZA00R200 installazione orizzontale, per art.ZA00V200 installazione verticale, con maniglie lisce, Inox AISI 316L

FINITURE DISPONIBILI

-  **D1** D1 Inox Spazzolato
-  **5H** 5H Dark Brass Brushed
-  **5L** 5L Black Titanium Spazzolato
-  **5N** 5N Oro Rosa Spazzolato

CARATTERISTICHE

Installazione **Incasso**  
 Parti Incasso necessarie **ZA00V200**  
**ZA00R200**

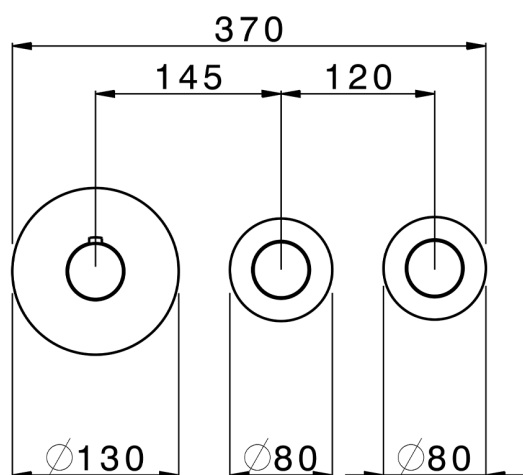

### Termostatico

Il Termostatico Cisal è il tuo personale gestore dell'acqua che ti aiuta a gestire e controllare acqua ed energia senza sprechi.



## Parte incasso termostatico doccia 2 funzioni INCASSO\_ZA00V200

MODELLO **ZA00V200**

Parte incasso termostatico doccia 2 funzioni

FINITURE DISPONIBILI



CARATTERISTICHE

Ricambio Cartuccia **23.51A.HF**

Incasso **1**

**Cartuccia Termostatica HF**



### Termostatico

Il Termostatico Cisal è il tuo personale gestore dell'acqua che ti aiuta a gestire e controllare acqua ed energia senza sprechi.



## Parte incasso termostatico 2 funzioni INCASSO\_ZA00R200

MODELLO **ZA00R200**

Parte incasso termostatico 2 funzioni

FINITURE DISPONIBILI



CARATTERISTICHE

Ricambio Cartuccia **23.51A.HF**

Incasso **1**

**Cartuccia Termostatica HF**



### Termostatico

Il Termostatico Cisal è il tuo personale gestore dell'acqua che ti aiuta a gestire e controllare acqua ed energia senza sprechi.



2026-05-02