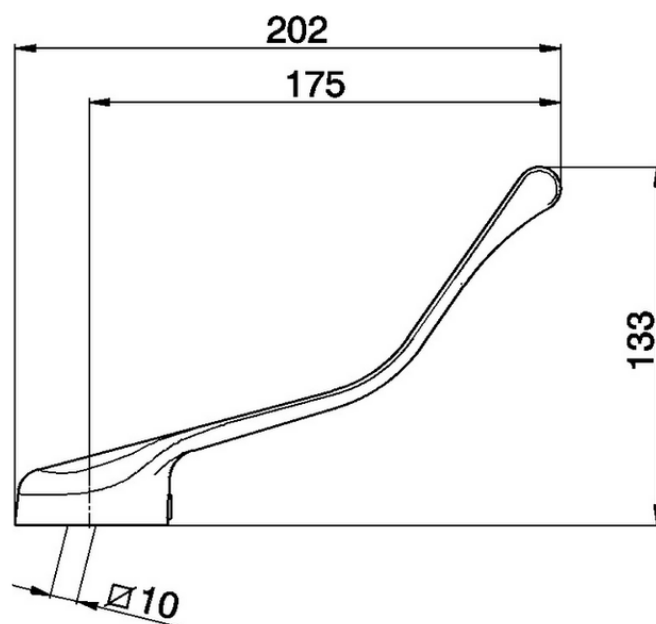

Leva clinica monocomando RICAMBI_ZA005001

ZA005001

<https://www.cisal.it/leva-clinica-monocomando-ricambi-za005001>

2026-05-11