







## Miscelatore monocomando vasca ROADSTER ACCENT\_RA000130

MODELLO **RA000130**

Miscelatore monocomando vasca, senza completo doccia, attacco per flessibile 1/2" M



### FINITURE DISPONIBILI

-  **21** 21 Cromo
-  **2B** 2B Nichel Lucido
-  **2F** 2F Nichel Spazzolato
-  **2Q** 2Q Black Titanium
-  **40** 40 Nero Opaco
-  **4Q** 4Q Bianco Opaco

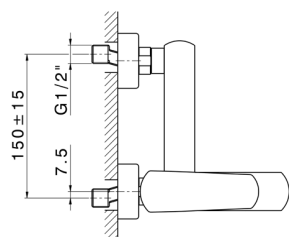
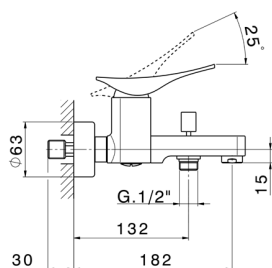

### CARATTERISTICHE

Ricambio Cartuccia **ZZ96799000**

**Cartuccia Monocomando 35 mm**



## Miscelatore monocomando vasca ROADSTER ACCENT\_RA000130

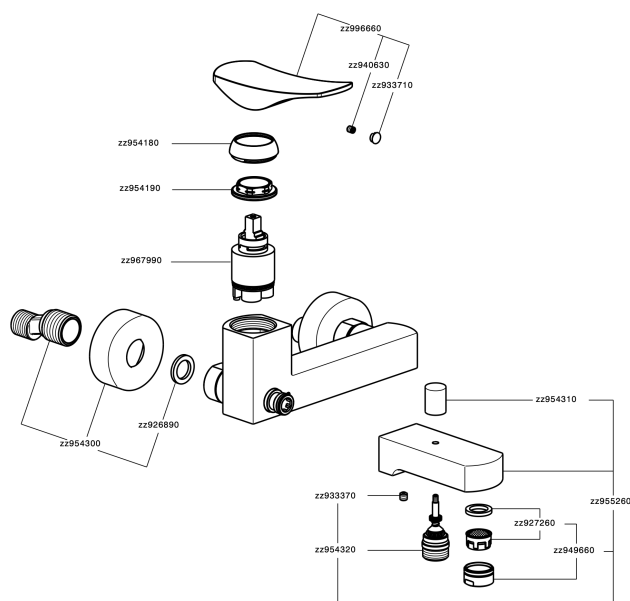

RA000130

<https://www.cisal.it/miscelatore-monocomando-vasca-roadster-accent-ra000130>

2026-06-21