

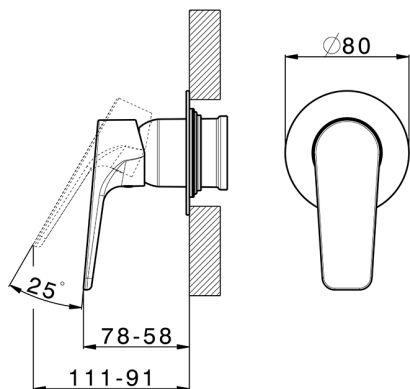

Parte esterna monocomando doccia incasso ROCK&ROLL_RK003000C



MODELLO **RK003000C**

Parte esterna monocomando doccia incasso, senza parte incasso, per art.ZA005300-ZA005301-ZA0G1700

FINITURE DISPONIBILI

-  **21** 21 Cromo
-  **2F** 2F Nichel Spazzolato
-  **40** 40 Nero Opaco
-  **2W** 2W Oro Spazzolato
-  **26** 26 Vecchio Rame
-  **3W** 3W Brushed Black Titanium
-  **43** 43 Salvia
-  **44** 44 Graphite
-  **45** 45 Argilla
-  **46** 46 Metal Bronze
-  **47** 47 Cemento
-  **4Q** 4Q Bianco Opaco

CARATTERISTICHE

Installazione	Incasso
Parti Incasso necessarie	ZA0G1700
	ZA005301
	ZA005300



Parte esterna monocomando doccia incasso ROCK&ROLL_RK003000C

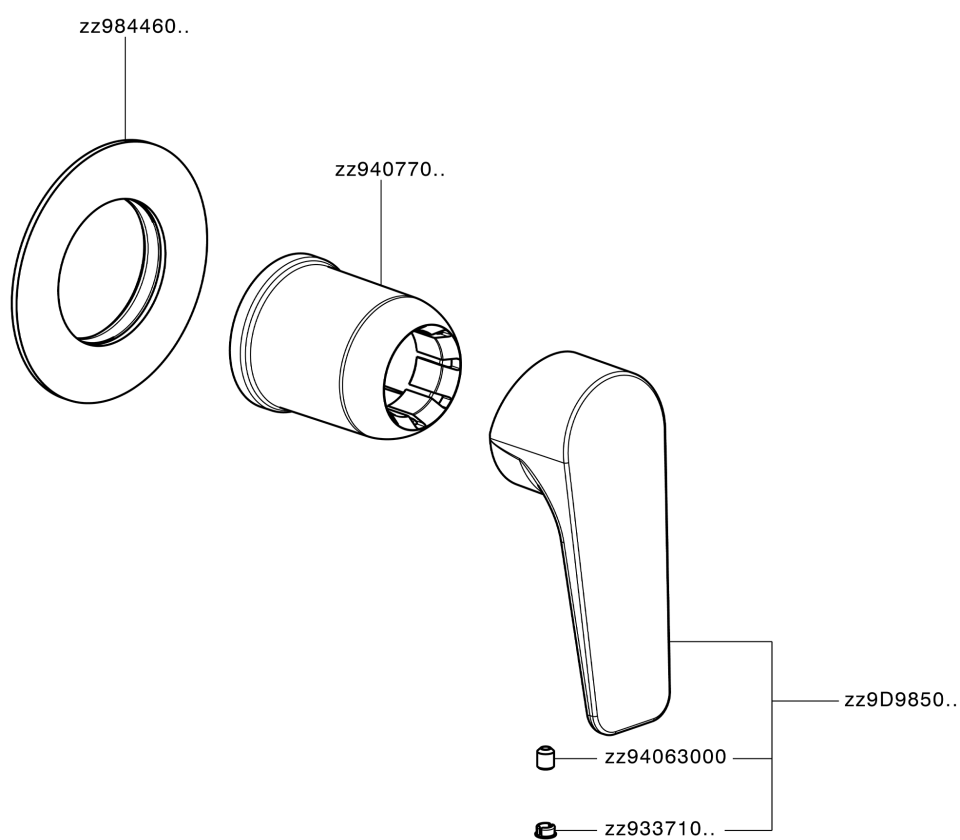

RK003000C

<https://www.cisal.it/parte-esterna-monocomando-doccia-incasso-rockroll-rk003000c>

Parte incasso monocomando doccia INCASSO_ZA005301

MODELLO **ZA005301**

Parte incasso monocomando doccia, doccia incasso 1/2", senza parte esterna, con silenziatori



FINITURE DISPONIBILI



04 04 Senza Finitura

CARATTERISTICHE

Ricambio Cartuccia **ZZ94035000**

Incasso **1**

Cartuccia Monocomando 35 mm

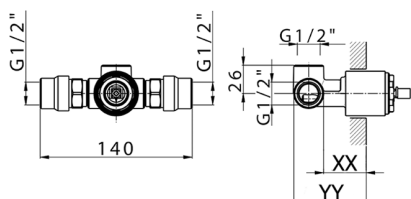

Piastra/Plate/Plaque/Platte/Placa
 2-3mm: XX 27-47 YY 54-74
 10mm: XX 16-40 YY 43-68



Parte incasso monocomando doccia INCASSO_ZA005300

MODELLO **ZA005300**

Parte incasso monocomando doccia, doccia incasso
1/2", senza parte esterna



FINITURE DISPONIBILI



04 04 Senza Finitura

CARATTERISTICHE

Ricambio Cartuccia **ZZ94035000**

Incasso **1**

Cartuccia Monocomando 35 mm

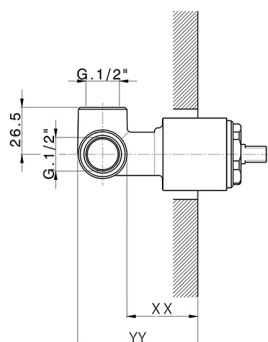

Piastra/Plate/Plaque/Platte/Placa
2-3mm: XX 27-47 YY 54-74
10mm: XX 16-40 YY 43-68



2026-04-30