

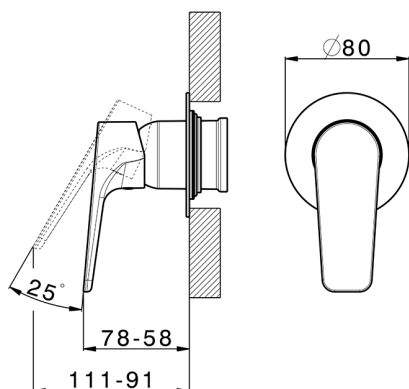

## Parte esterna monocomando doccia incasso ROCK&ROLL\_RK003000C



MODELLO **RK003000C**

Parte esterna monocomando doccia incasso, senza parte incasso, per art.ZA005300-ZA005301-ZA0G1700

### FINITURE DISPONIBILI

-  **21** 21 Cromo
-  **2F** 2F Nichel Spazzolato
-  **40** 40 Nero Opaco
-  **2W** 2W Oro Spazzolato
-  **26** 26 Vecchio Rame
-  **3W** 3W Brushed Black Titanium
-  **43** 43 Salvia
-  **44** 44 Graphite
-  **45** 45 Argilla
-  **46** 46 Metal Bronze
-  **47** 47 Cemento
-  **4Q** 4Q Bianco Opaco

## CARATTERISTICHE

Installazione	<b>Incasso</b>
Parti Incasso necessarie	<b>ZA0G1700</b>
	<b>ZA005301</b>
	<b>ZA005300</b>



## Parte esterna monocomando doccia incasso ROCK&ROLL\_RK003000C

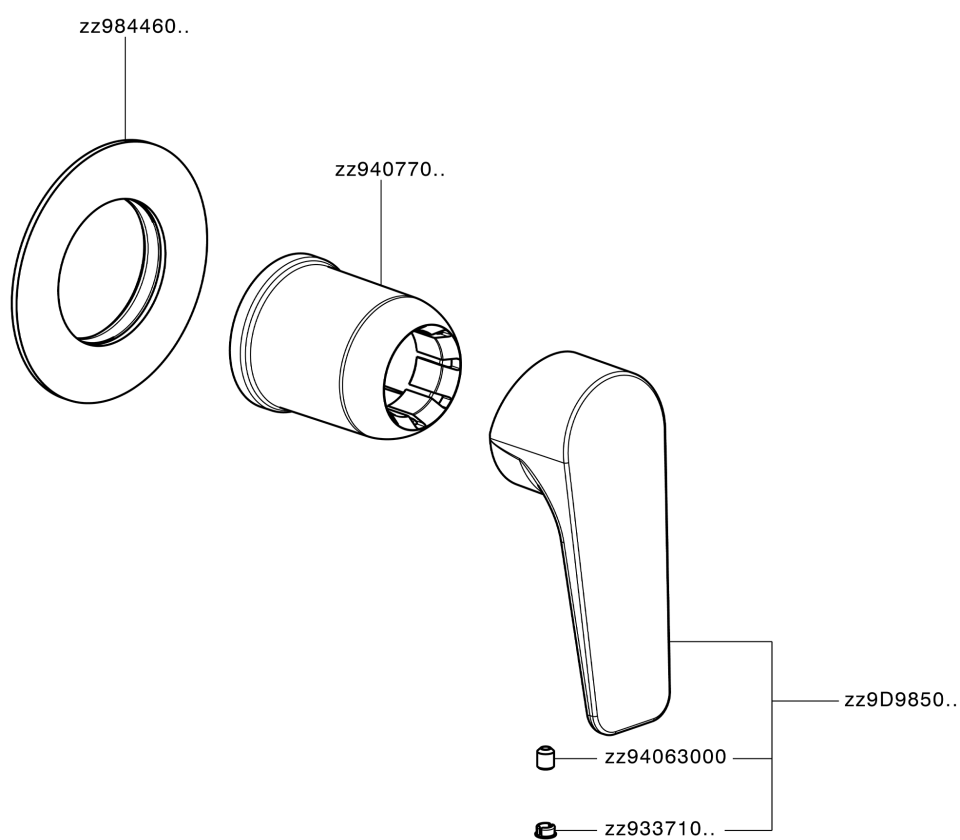

RK003000C

<https://www.cisal.it/parte-esterna-monocomando-doccia-incasso-rockroll-rk003000c>

## Parte incasso monocomando doccia INCASSO\_ZA005301

MODELLO **ZA005301**

Parte incasso monocomando doccia, doccia incasso 1/2", senza parte esterna, con silenziosi



FINITURE DISPONIBILI



**04** 04 Senza Finitura

CARATTERISTICHE

Ricambio Cartuccia **ZZ94035000**

Incasso **1**

**Cartuccia Monocomando 35 mm**

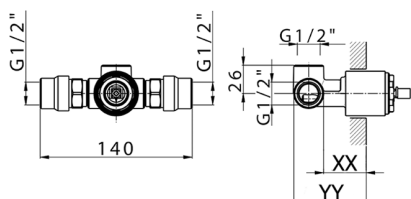

Piastra/Plate/Plaque/Platte/Placa  
 2-3mm: XX 27-47 YY 54-74  
 10mm: XX 16-40 YY 43-68



## Parte incasso monocomando doccia INCASSO\_ZA005300

MODELLO **ZA005300**

Parte incasso monocomando doccia, doccia incasso  
1/2", senza parte esterna

FINITURE DISPONIBILI

 **04** 04 Senza Finitura



CARATTERISTICHE

Ricambio Cartuccia **ZZ94035000**

Incasso **1**

**Cartuccia Monocomando 35 mm**

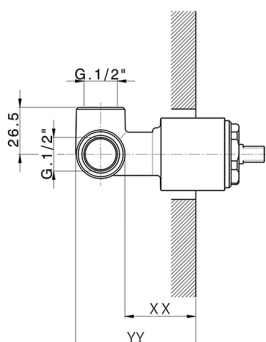

Piastra/Plate/Plaque/Platte/Placa  
2-3mm: XX 27-47 YY 54-74  
10mm: XX 16-40 YY 43-68



2026-05-04