

Parte esterna termo doccia incasso 3 funzioni WELLNESS_GS00R300

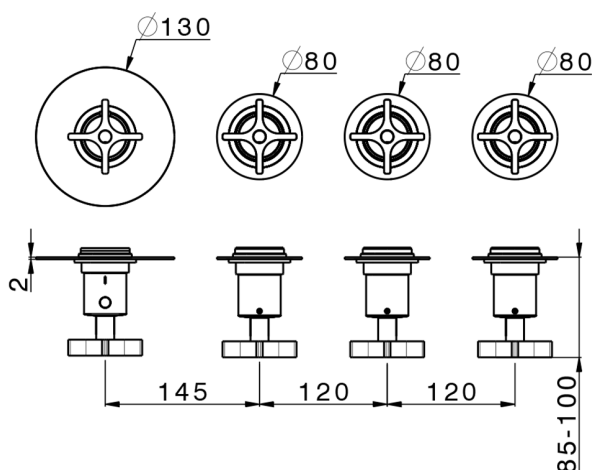
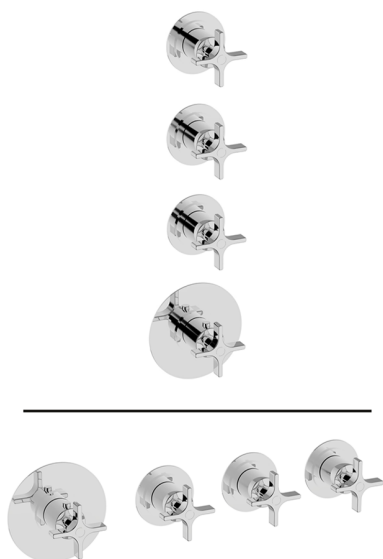

MODELLO **GS00R300**

Parte esterna termo doccia incasso 3 funzioni, per art.ZA00R300 installazione orizzontale, per art.ZA00V300 installazione verticale

FINITURE DISPONIBILI

-  **21** 21 Cromo
-  **2F** 2F Nichel Spazzolato
-  **2W** 2W Oro Spazzolato
-  **5H** 5H Dark Brass Brushed
-  **5L** 5L Black Titanium Spazzolato
-  **6T** 6T Cromo/Nero Opaco

CARATTERISTICHE

Installazione **Incasso**
 Parti Incasso necessarie **ZA00V300**
ZA00R300



Termostatico

Il Termostatico Cisal è il tuo personale gestore dell'acqua che ti aiuta a gestire e controllare acqua ed energia senza sprechi.



Parte incasso termostatico 3 funzioni INCASSO_ZA00V300

MODELLO **ZA00V300**

Parte incasso termostatico 3 funzioni

FINITURE DISPONIBILI

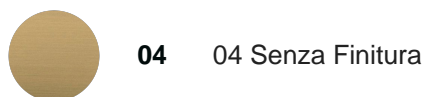

CARATTERISTICHE

Ricambio Cartuccia **23.51A.HF**

Incasso **1**

Cartuccia Termostatica HF

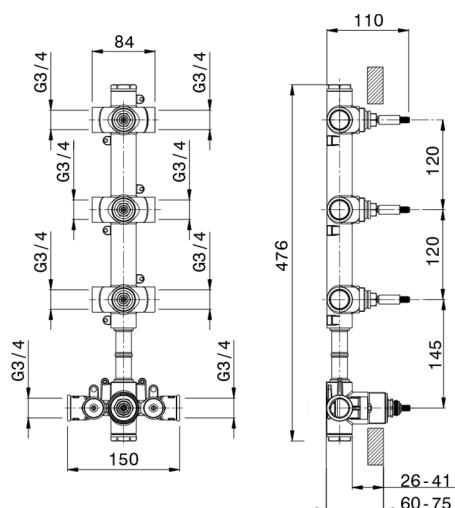

Termostatico

Il Termostatico Cisal è il tuo personale gestore dell'acqua che ti aiuta a gestire e controllare acqua ed energia senza sprechi.



Parte incasso termostatico 3 funzioni INCASSO_ZA00R300

MODELLO **ZA00R300**

Parte incasso termostatico 3 funzioni

FINITURE DISPONIBILI

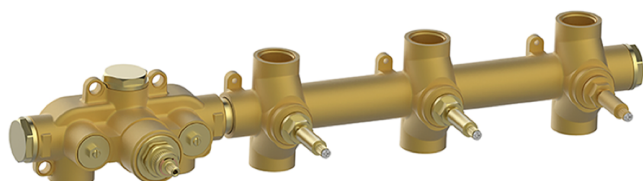
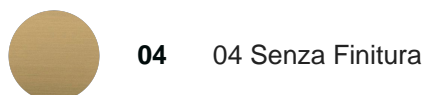

CARATTERISTICHE

Ricambio Cartuccia **23.51A.HF**

Incasso **1**

Cartuccia Termostatica HF

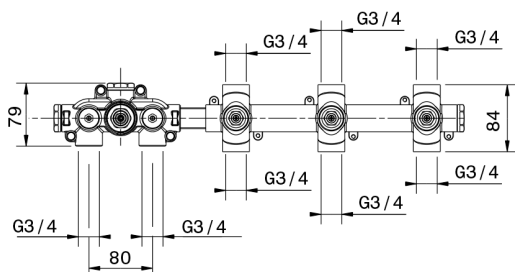
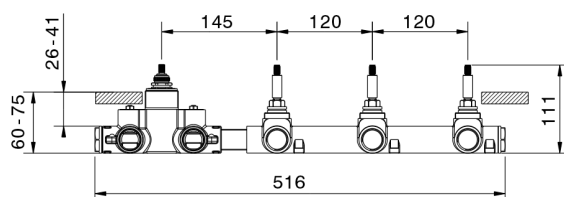

Termostatico

Il Termostatico Cisal è il tuo personale gestore dell'acqua che ti aiuta a gestire e controllare acqua ed energia senza sprechi.



2026-05-02