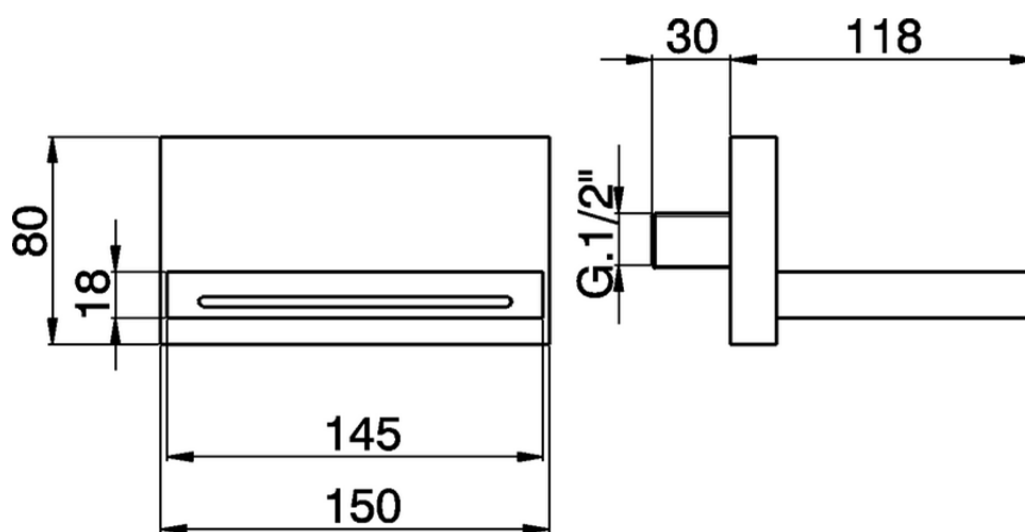

Bocca di erogazione COMPLEMENTI_ZA002200

ZA002200

<https://www.cisal.it/bocca-di-erogazione-complementi-za002200>

2026-06-23