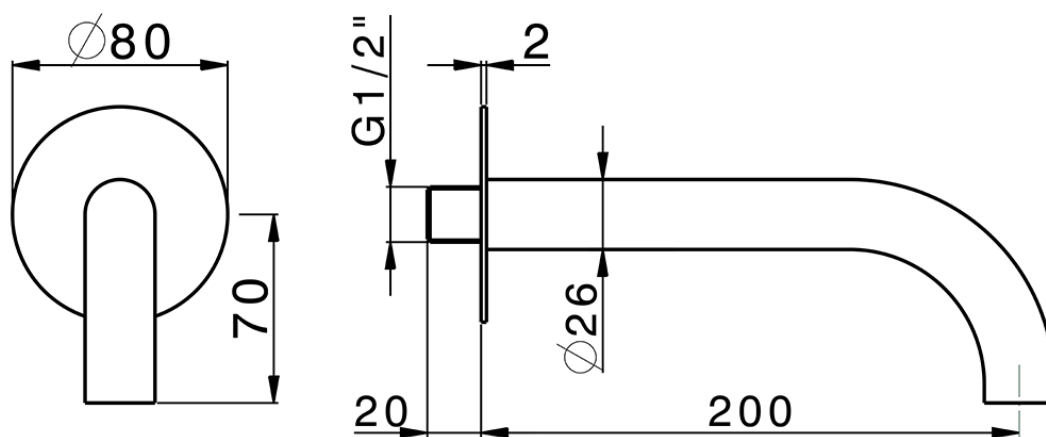

**Bocca di erogazione PUSH&SHOWER\_ZA0G5100**

ZA0G5100

<https://www.cisal.it/bocca-di-erogazione-pushshower-za0g5100>

2026-05-30