

Completo Monocomando per One-Box ONE BOX_RI0BM030

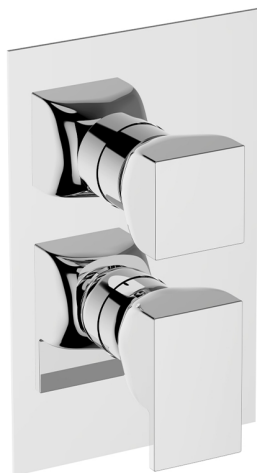

MODELLO **RI0BM030**

Completo Monocomando per One-Box, con deviatore 2-3 uscite, profondità minima di installazione 67 mm, senza parte incasso, per art. ZA00B030-ZA00B031

FINITURE DISPONIBILI

- 
21 21 Cromo
- 
24 24 Oro
- 
2F 2F Nichel Spazzolato
- 
2W 2W Oro Spazzolato
- 
40 40 Nero Opaco
- 
4Q 4Q Bianco Opaco
- 
5G 5G Oro Rosa
- 
6V 6V Bianco Opaco/Nichel Spazzolato
- 
6X 6X Bianco Opaco/Oro Spazzolato
- 
7W 7W Nero Opaco/Oro Spazzolato

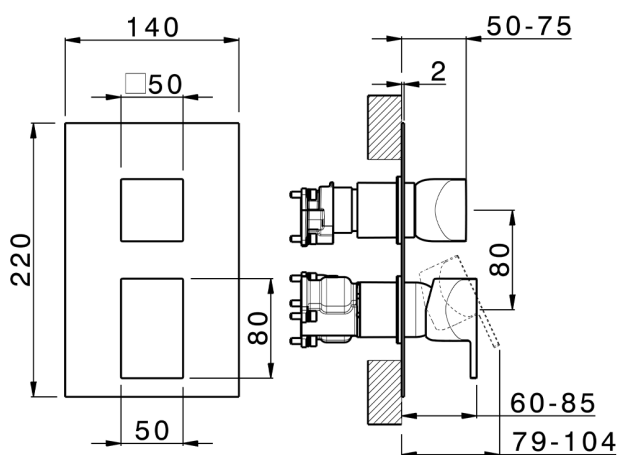

CARATTERISTICHE

Ricambio Cartuccia **ZZ97179000**

Cartuccia Monocomando 35 mm

Installazione **Incasso**

Parti Incasso necessarie **ZA00B031**

ZA00B030



One-Box Universale per incasso ONE BOX_ZA00B031

MODELLO **ZA00B031**

One-Box Universale per incasso, per termostatico o monocomando 1, 2 o 3 uscite, senza parte esterna, con silenziosi, con guarnizione per sigillatura

FINITURE DISPONIBILI

 **04** 04 Senza Finitura

CARATTERISTICHE

Incasso **1**



Termostatico

Il Termostatico Cisal è il tuo personale gestore dell'acqua che ti aiuta a gestire e controllare acqua ed energia senza sprechi.



One-Box Universale per incasso ONE BOX_ZA00B030



MODELLO **ZA00B030**

One-Box Universale per incasso, per termostatico o monocomando 1, 2 o 3 uscite, senza parte esterna, senza silenziosi, con guarnizione per sigillatura

FINITURE DISPONIBILI

 **04** 04 Senza Finitura

CARATTERISTICHE

Incasso **1**



Termostatico

Il Termostatico Cisal è il tuo personale gestore dell'acqua che ti aiuta a gestire e controllare acqua ed energia senza sprechi.



2026-06-12