

## Colonna doccia monocomando 2 funzioni COLONNE DOCCIA\_ST005050

# cisal

### ST 00505 - ST 000510

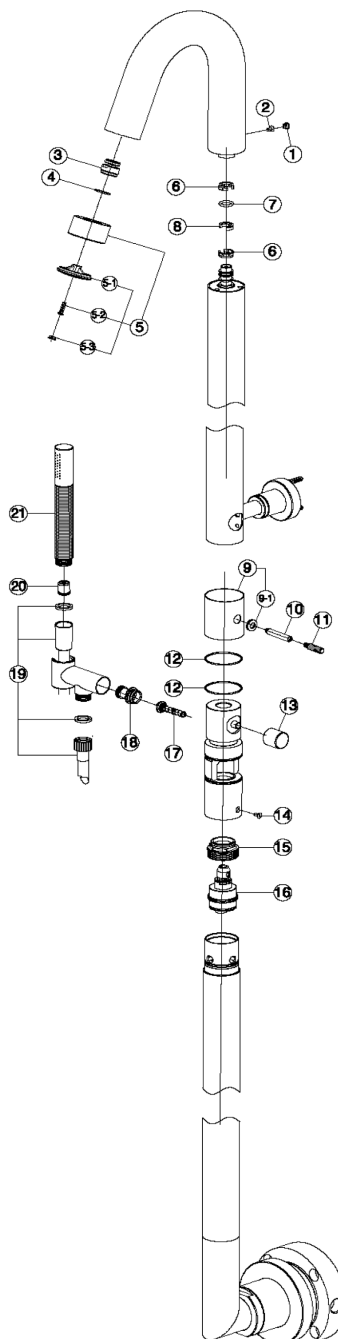
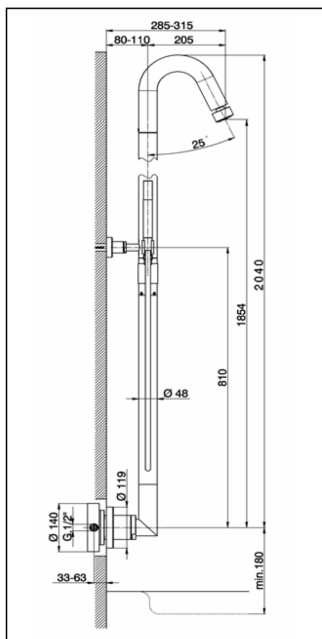

ST005050

<https://www.cisal.it/colonna-doccia-monocomando-2-funzioni-colonne-doccia-st005050>

## Colonna doccia monocomando 2 funzioni COLONNE DOCCIA\_ST005050

# cisal

### ST 00505 - ST 000510

NR.	DESCRIZIONE DESCRIPTION BESCHREIBUNG DESCRIPTION	N.CODICE CODE NO. WERSKNR. NR.CODE	NR.	DESCRIZIONE DESCRIPTION BESCHREIBUNG DESCRIPTION	N.CODICE CODE NO. WERSKNR. NR.CODE	NR.	DESCRIZIONE DESCRIPTION BESCHREIBUNG DESCRIPTION	N.CODICE CODE NO. WERSKNR. NR.CODE
1	Placchetta per leva neutra Cap for lever Abdeckkappe f/Hebel Plaquette levier	ZZ927110	7	O.R. 11 NBR 75 SH. O.R. 11 NBR 75 SH. O.R. 11 NBR 75 SH. O.R. 11 NBR 75 SH.	ZZ926900	15	Calotta bloccaggio cartuccia Nut for mixing valve Mutter f/Kartusche Ecrou pour cartouche	ZZ937930
2	Vite M.6 Screw M.6 Schraube M.6 Vis M.6	ZZ941090	8	Rondella antifrizione Dichtung fuer Huelse Washer for covering tube Joint pour bague couverture	ZZ941030	16	Cartuccia monocomando Mixing valve Kartusche Cartouche mitigeurs	ZZ937920
3	Snodo 20/22 Joint 20/22 Gelenkstueck 20/22 Rotule 20/22	ZZ941120	9	Canotto copricartuccia Tube for escutcheon Huelse f.Abdeckkappe Canot couvre-cartouche	ZZ937890	17	Asta deviazione completa Complete diverting rod Umstellung Tige inverseur complete	ZZ933140
4	Guarnizione 20,8x16x1,5 Gasket 20,8x16x1,5 Dichtung 20,8x16x1,5 Joint 20,8x16x1,5	ZZ941130	9-1	Guarnizione per canotto copricartuccia Gasket for tube for escutcheon Dichtung Huelse f.Abdeckkappe Joint pour canot couvre-cartouche	ZZ937900	18	Perno di fissaggio Pin Zapfen Vis	ZZ942390
5	Corpo soffione doccia Showerhead's body Koeper der Kopfbrause Corps pomme de douche	ZZ941100	10	Asta leva monocomando Rod for Lever Stange fuer Hebel Tige levier mitigeur	ZZ937910	19	Flex PVC 150 cm Ø14 1/2"x1/2" conico Flex PVC 150 cm Ø14 1/2"x1/2" Braueschl. PVC 150 cm Ø14 1/2"x1/2" Flex.PVC 150 cm Ø14 1/2"x1/2"	ZA009030
5-1	Disco soffione doccia Showerhead's disc Disk der Kopfbrause Disque pour pomme de douche	ZZ941140	11	Terminale leva "LS" Knob for lever "LS" Design Griffelement "LS" Embout levier "LS"	LS010000	20	Valvola anti-ritorno Ø15 per doccia Back-flow valve Ø15 Durchflussverhinderer Ø15 Clapet anti-retour Ø15	ZZ929560
5-2	Vite W.3/16x16 tb. Screw W.3/16x16 tb. Schraube W.3/16x16 tb. Vis W.3/16x16 tb.	ZZ941150	12	Rondella antifrizione Dichtung fuer Huelse Washer for covering tube Joint pour bague couverture	ZZ937940	21	Doccia minimale Minimal handshower Handbrause minimal Douchette minimal	DS014090
5-3	Placchetta Cap Abdeckkappe Plaquette	ZZ941160	13	Pomolo per deviazione Knob for diverter Zugknopf Umsteller Pommeau pour inverseur	ZZ933290			
6	Anello per canna Ring for spout Ring fuer Auslauf Bague pour bec	ZZ941020	14	Vite M.4x8 Screw M.4x8 Schraube M.4x8 Vis M.4x8	ZZ938030			

ST005050

<https://www.cisal.it/colonna-doccia-monocomando-2-funzioni-colonne-doccia-st005050>

2026-06-25