







Parte esterna termo doccia incasso 3 funzioni ROADSTER ACCENT_RA01V300

MODELLO **RA01V300**

Parte esterna termo doccia incasso 3 funzioni, per art. ZA01V300

FINITURE DISPONIBILI

-  **21** 21 Cromo
-  **2B** 2B Nichel Lucido
-  **2F** 2F Nichel Spazzolato
-  **2Q** 2Q Black Titanium
-  **40** 40 Nero Opaco
-  **4Q** 4Q Bianco Opaco

CARATTERISTICHE

Installazione **Incasso**
Parti Incasso necessarie **ZA01V300**

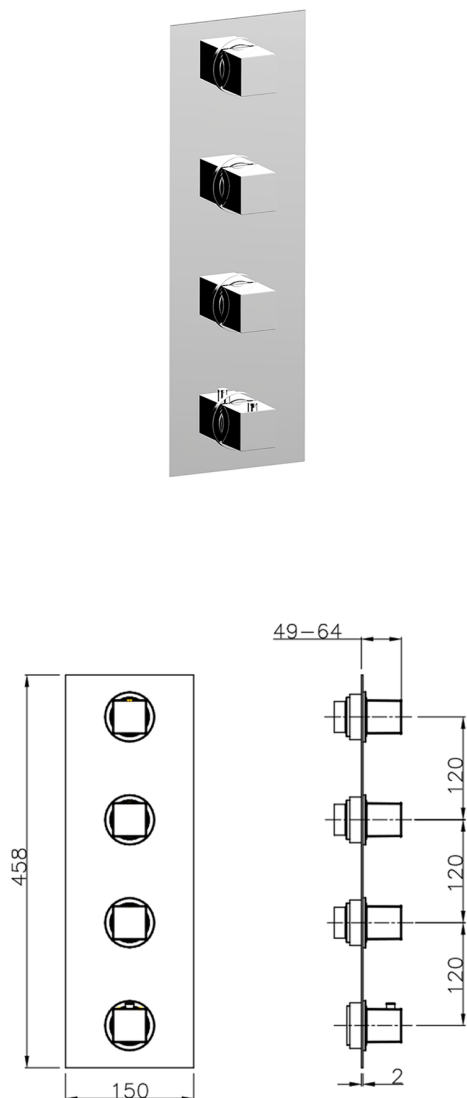

Termostatico

Il Termostatico Cisal è il tuo personale gestore dell'acqua che ti aiuta a gestire e controllare acqua ed energia senza sprechi.



Parte esterna termo doccia incasso 3 funzioni ROADSTER ACCENT_RA01V300

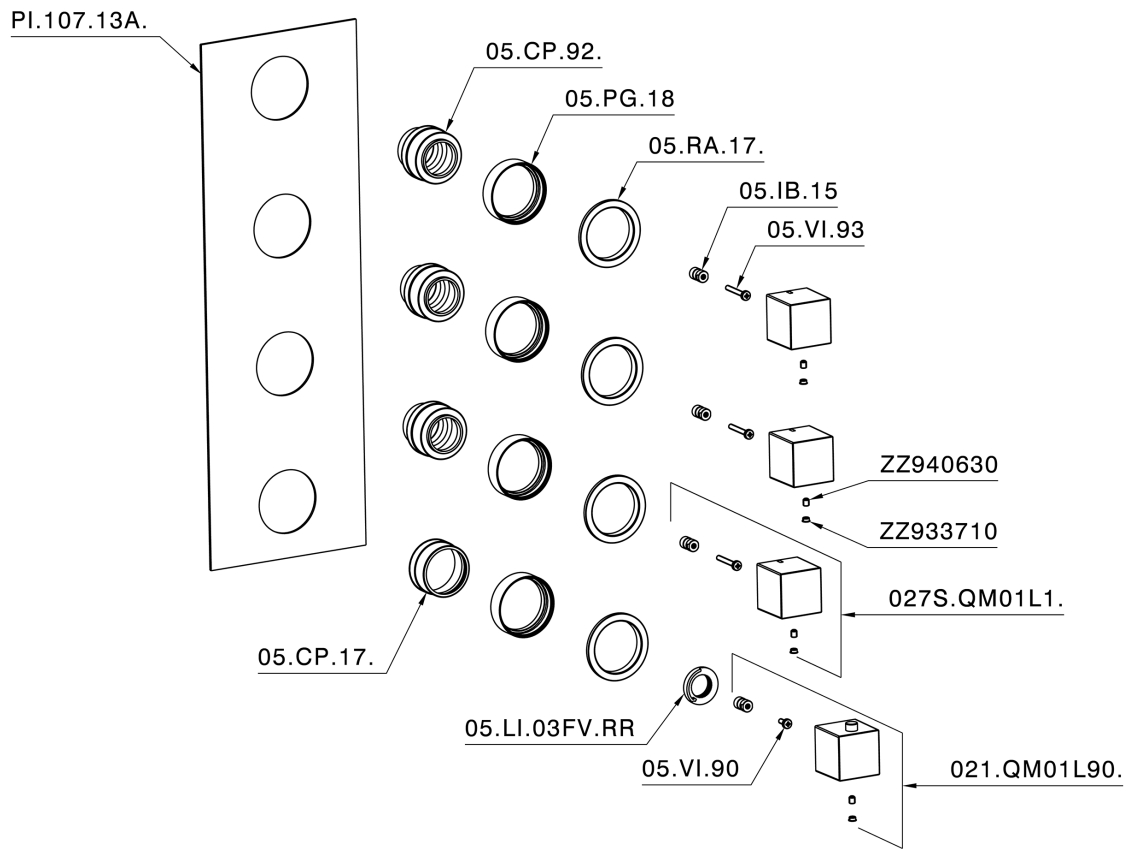

RA01V300

<https://www.cisal.it/parte-esterna-termo-doccia-incasso-3-funzioni-roadster-accent-ra01v300>

Parte incasso termostatico 3 funzioni INCASSO_ZA01V300

MODELLO **ZA01V300**

Parte incasso termostatico 3 funzioni

FINITURE DISPONIBILI



CARATTERISTICHE

Ricambio Cartuccia **23.51A.HF**

Incasso **1**

Cartuccia Termostatica HF



Termostatico

Il Termostatico Cisal è il tuo personale gestore dell'acqua che ti aiuta a gestire e controllare acqua ed energia senza sprechi.



2026-06-21