

Parte esterna per singolo Push&Shower PUSH&SHOWER_PS1G6120

MODELLO **PS1G6120**

Parte esterna per singolo Push&Shower, pulsante con design quadrettato, piastra tonda Ø80 mm, per incasso Push&Shower

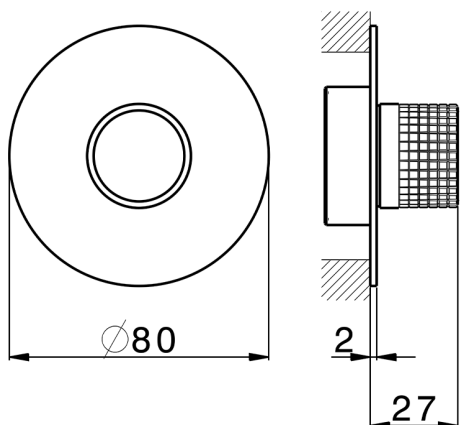
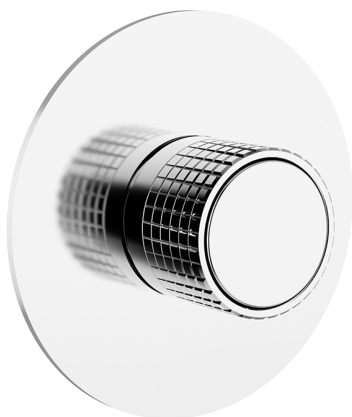

FINITURE DISPONIBILI

-  **21** 21 Cromo
-  **24** 24 Oro
-  **26** 26 Vecchio Rame
-  **2B** 2B Nichel Lucido
-  **2F** 2F Nichel Spazzolato
-  **2W** 2W Oro Spazzolato
-  **3W** 3W Brushed Black Titanium
-  **5G** 5G Oro Rosa
-  **40** 40 Nero Opaco



Termostatico

Il Termostatico Cisal è il tuo personale gestore dell'acqua che ti aiuta a gestire e controllare acqua ed energia senza sprechi.

CARATTERISTICHE

Installazione **Incasso**
Parti Incasso necessarie **ZA0G6000**



2026-05-30