

Bocca di erogazione COMPLEMENTI_ZA001252

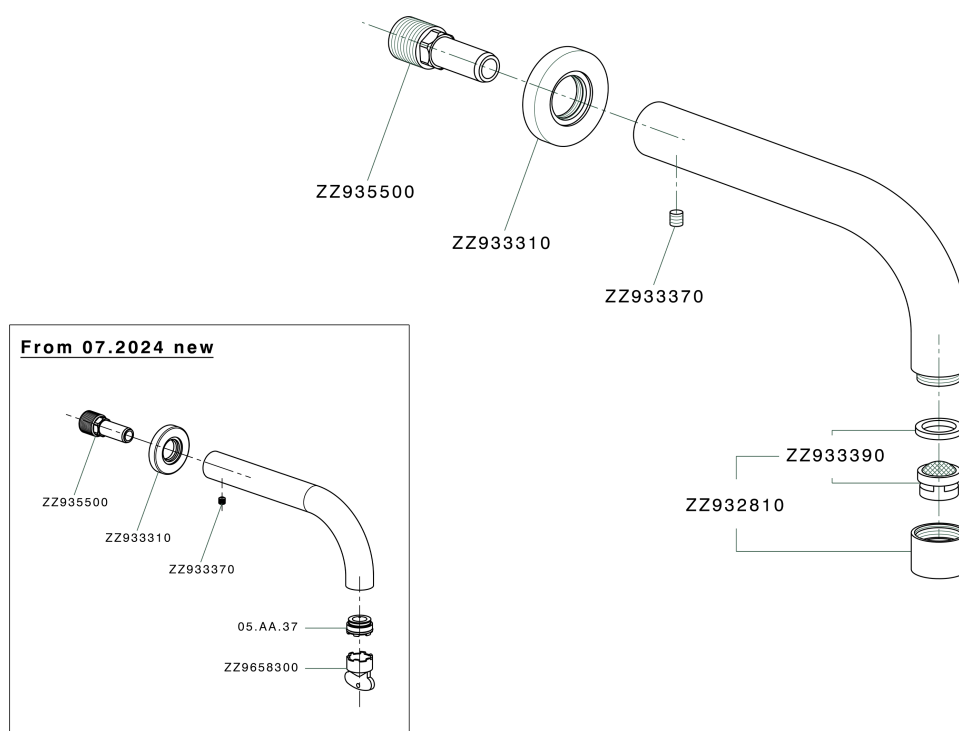

ZA001252

<https://www.cisal.it/bocca-di-erogazione-complementi-za001252>

2026-07-05