

## Completo Monocomando per One-Box ONE BOX\_RI0BM010



MODELLO **RI0BM010**

Completo Monocomando per One-Box, 1 uscita, profondità minima di installazione 67 mm, senza parte incasso, per art. ZA00B030-ZA00B031

### FINITURE DISPONIBILI

- 
**21** 21 Cromo
- 
**24** 24 Oro
- 
**2F** 2F Nichel Spazzolato
- 
**2W** 2W Oro Spazzolato
- 
**40** 40 Nero Opaco
- 
**4Q** 4Q Bianco Opaco
- 
**5G** 5G Oro Rosa
- 
**6V** 6V Bianco Opaco/Nichel Spazzolato
- 
**6X** 6X Bianco Opaco/Oro Spazzolato
- 
**7W** 7W Nero Opaco/Oro Spazzolato

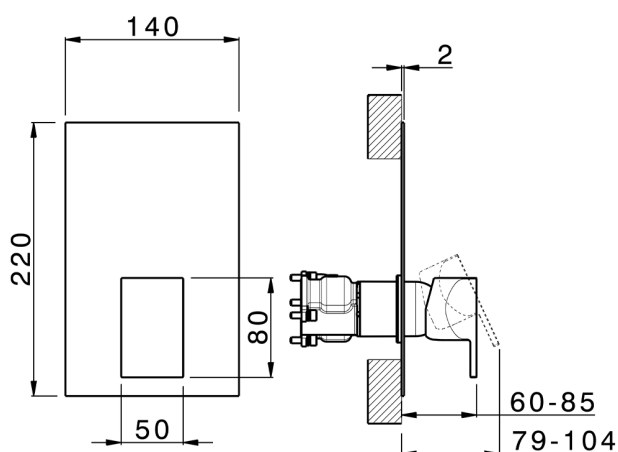

### CARATTERISTICHE

Ricambio Cartuccia **ZZ97179000**

**Cartuccia Monocomando 35 mm**

Installazione **Incasso**

Parti Incasso necessarie **ZA00B031**

**ZA00B030**



## One-Box Universale per incasso ONE BOX\_ZA00B031

MODELLO **ZA00B031**

One-Box Universale per incasso, per termostatico o monocomando 1, 2 o 3 uscite, senza parte esterna, con silenziosi, con guarnizione per sigillatura

FINITURE DISPONIBILI

 **04** 04 Senza Finitura

CARATTERISTICHE

Incasso **1**



### Termostatico

Il Termostatico Cisal è il tuo personale gestore dell'acqua che ti aiuta a gestire e controllare acqua ed energia senza sprechi.



## One-Box Universale per incasso ONE BOX\_ZA00B030

MODELLO **ZA00B030**

One-Box Universale per incasso, per termostatico o monocomando 1, 2 o 3 uscite, senza parte esterna, senza silenziosi, con guarnizione per sigillatura

FINITURE DISPONIBILI

 **04** 04 Senza Finitura

CARATTERISTICHE

Incasso **1**



### Termostatico

Il Termostatico Cisal è il tuo personale gestore dell'acqua che ti aiuta a gestire e controllare acqua ed energia senza sprechi.



2026-04-27