





Parte esterna rubinetto NUOVA LESS_LN003310

MODELLO **LN003310**

Parte esterna rubinetto, senza parte incasso, per art. ZA003330-ZA003340



FINITURE DISPONIBILI

-  **21** 21 Cromo
-  **2F** 2F Nichel Spazzolato
-  **40** 40 Nero Opaco
-  **4Q** 4Q Bianco Opaco

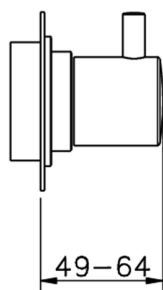
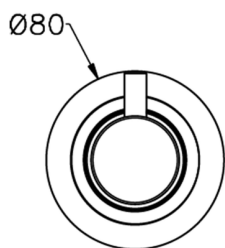

CARATTERISTICHE

Installazione **Incasso**
 Parti Incasso necessarie **ZA003340**
ZA003330



Parte incasso rubinetto 1/2" INCASSO_ZA003340

MODELLO **ZA003340**

Parte incasso rubinetto 1/2", apertura in senso antiorario



FINITURE DISPONIBILI

 **04** 04 Senza Finitura

CARATTERISTICHE

Incasso **1**

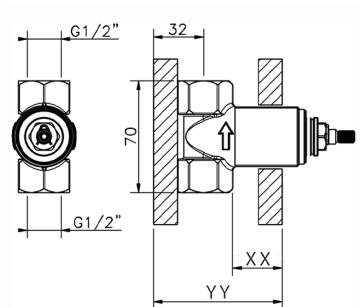

Piastra/Plate/Plaque/Platte/Placa
 2-3mm: XX 31-46 YY 80-95
 10mm: XX 25-40 YY 76-91



Parte incasso rubinetto 3/4" INCASSO_ZA003330

MODELLO **ZA003330**

Parte incasso rubinetto 3/4", apertura in senso antiorario



FINITURE DISPONIBILI



04 04 Senza Finitura

CARATTERISTICHE

Incasso **1**



Piastra/Plate/Plaque/Platte/Placa

2-3mm: XX 31-46 YY 80-95

10mm: XX 25-40 YY 76-91



2026-05-22