

Parte esterna termo doccia incasso 3 funzioni NUANCE X32_X100R300

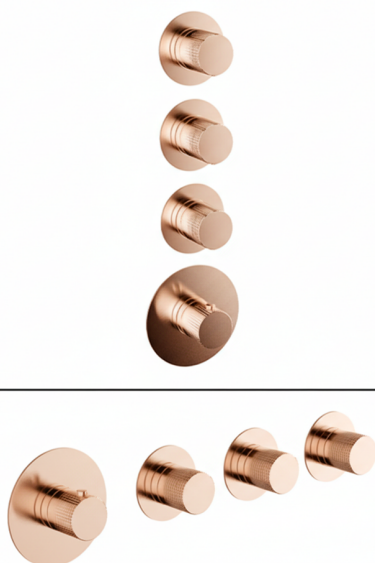

MODELLO **X100R300**

Parte esterna termo doccia incasso 3 funzioni, per art.ZA00R300 installazione orizzontale, per art.ZA00V300 installazione verticale, Inox AISI 316L

FINITURE DISPONIBILI

-  **D1** D1 Inox Spazzolato
-  **5H** 5H Dark Brass Brushed
-  **5L** 5L Black Titanium Spazzolato
-  **5N** 5N Oro Rosa Spazzolato

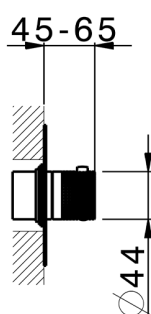
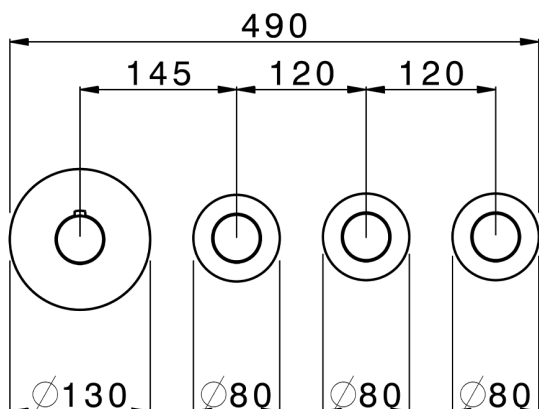

CARATTERISTICHE

Installazione **Incasso**
 Parti Incasso necessarie **ZA00V300**
ZA00R300



Termostatico

Il Termostatico Cisal è il tuo personale gestore dell'acqua che ti aiuta a gestire e controllare acqua ed energia senza sprechi.



Parte esterna termo doccia incasso 3 funzioni NUANCE X32_X100R300

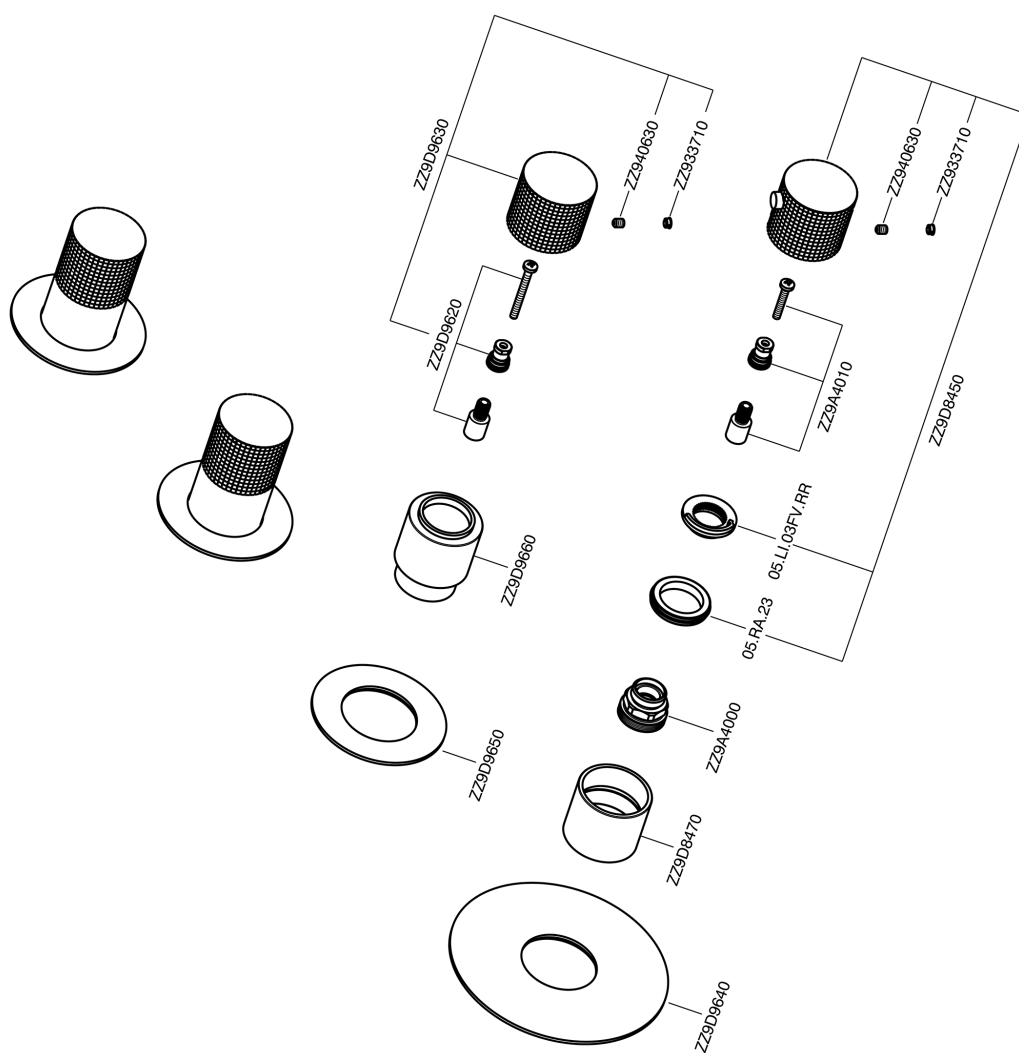

X100R300

<https://www.cisal.it/parte-esterna-termo-doccia-incasso-3-funzioni-nuance-x32-x100r300>

Parte incasso termostatico 3 funzioni INCASSO_ZA00V300

MODELLO **ZA00V300**

Parte incasso termostatico 3 funzioni

FINITURE DISPONIBILI

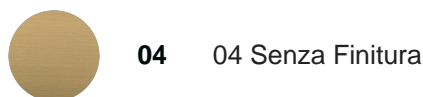

CARATTERISTICHE

Ricambio Cartuccia **23.51A.HF**

Incasso **1**

Cartuccia Termostatica HF

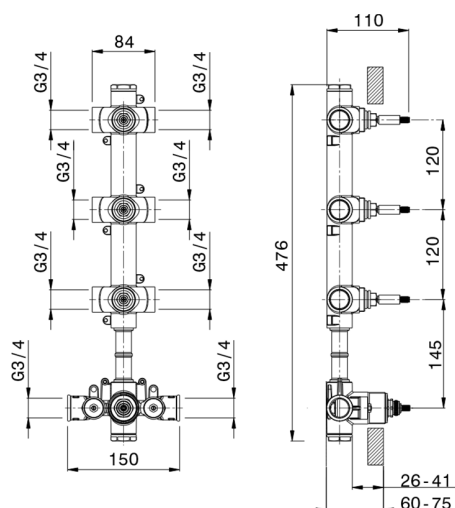

Termostatico

Il Termostatico Cisal è il tuo personale gestore dell'acqua che ti aiuta a gestire e controllare acqua ed energia senza sprechi.



Parte incasso termostatico 3 funzioni INCASSO_ZA00R300

MODELLO **ZA00R300**

Parte incasso termostatico 3 funzioni

FINITURE DISPONIBILI

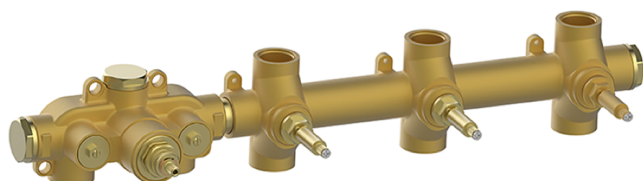
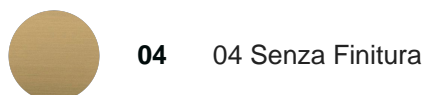

CARATTERISTICHE

Ricambio Cartuccia **23.51A.HF**

Incasso **1**

Cartuccia Termostatica HF

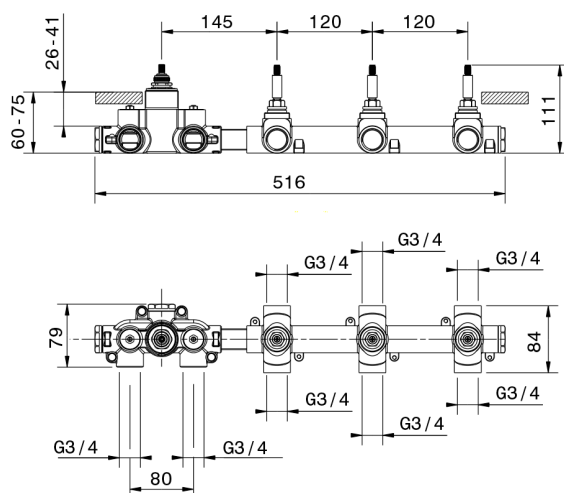

Termostatico

Il Termostatico Cisal è il tuo personale gestore dell'acqua che ti aiuta a gestire e controllare acqua ed energia senza sprechi.



2026-03-07