

Colonna doccia monocomando 2 funzioni ARCANA EMPRESS_EM004050

MODELLO **EM004050**

Colonna doccia monocomando 2 funzioni,deviatore 2 uscite,colonna telescopica,con supporto doccetta fisso,doccetta monogetto Toscana,soffione tondo D.200 mm in Ottone,flex Ottone 150 cm

FINITURE DISPONIBILI

-  **21** 21 Cromo
-  **24** 24 Oro
-  **26** 26 Vecchio Rame
-  **27** 27 Vecchio Bronzo
-  **2A** 2A Nichel Satinato Spazzolato
-  **74** 74 Cromo/Oro

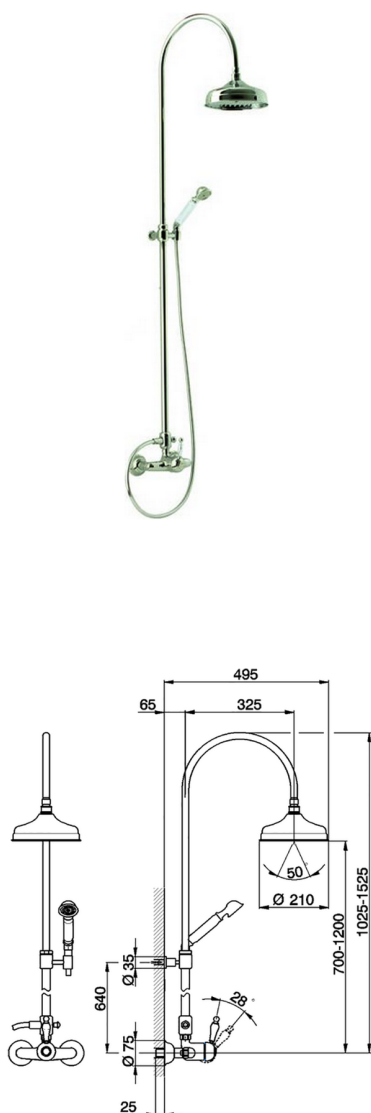

CARATTERISTICHE

Ricambio Cartuccia **ZZ92909000**

Cartuccia Monocomando 43 mm



Colonna doccia monocomando 2 funzioni ARCANA EMPRESS_EM004050

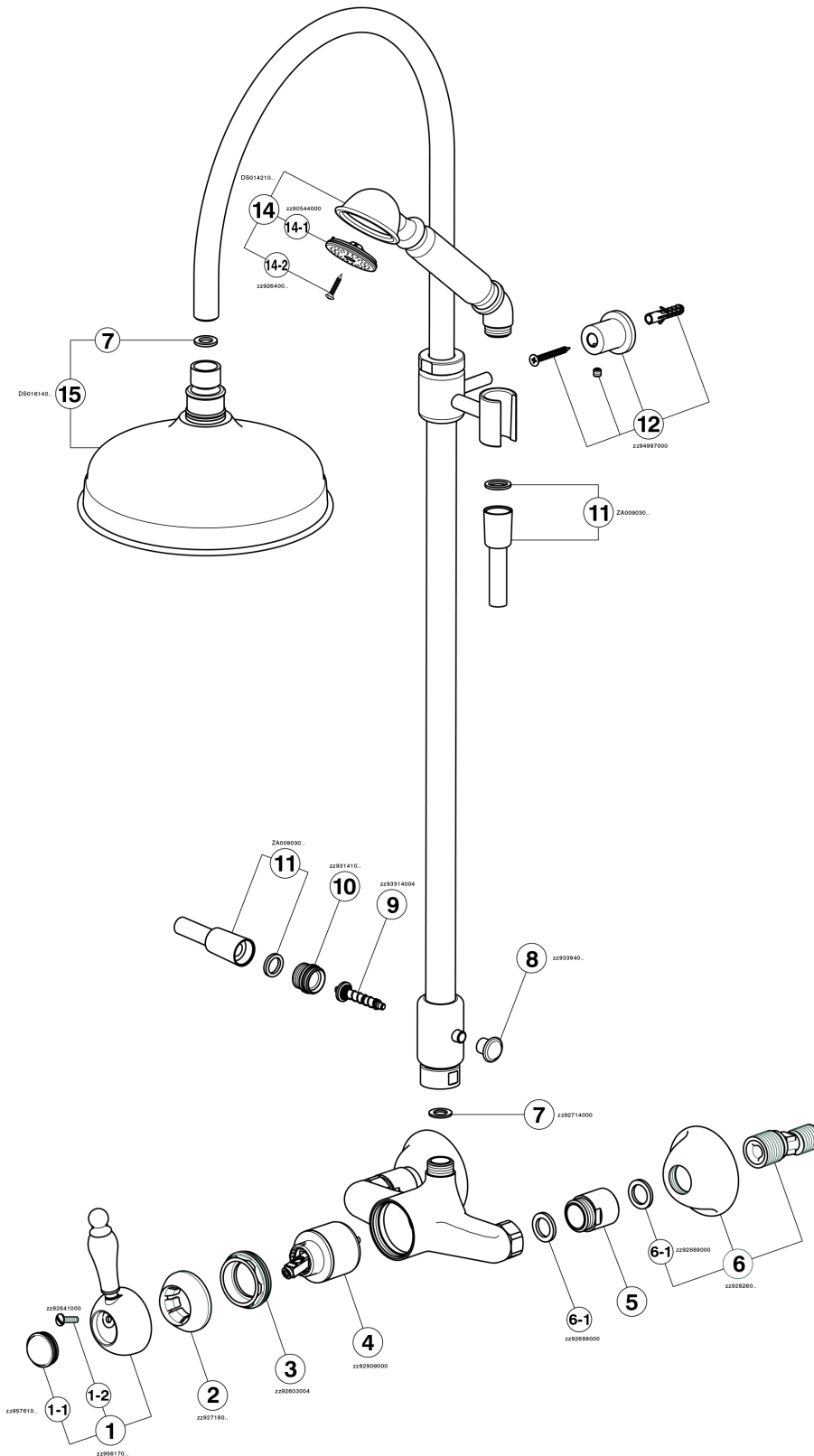

EM004050

<https://www.cisal.it/colonna-doccia-monocomando-2-funzioni-arcana-empress-em004050>

2026-04-14