

Parte esterna termostatico doccia incasso 1 uscita CUBIC_CU007300

MODELLO **CU007300**

Parte esterna termostatico doccia incasso 1 uscita, rubinetto d'arresto, senza parte incasso, per art. ZA007301



FINITURE DISPONIBILI

-  **21** 21 Cromo
-  **2B** 2B Nichel Lucido
-  **2F** 2F Nichel Spazzolato
-  **40** 40 Nero Opaco

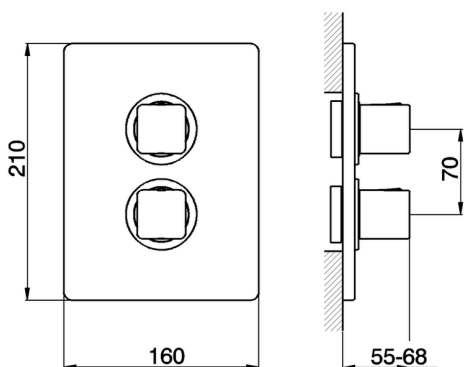

CARATTERISTICHE

Installazione **Incasso**
 Parti Incasso necessarie **ZA007301**



Termostatico

Il Termostatico Cisal è il tuo personale gestore dell'acqua che ti aiuta a gestire e controllare acqua ed energia senza sprechi.



Parte esterna termostatico doccia incasso 1 uscita CUBIC_CU007300

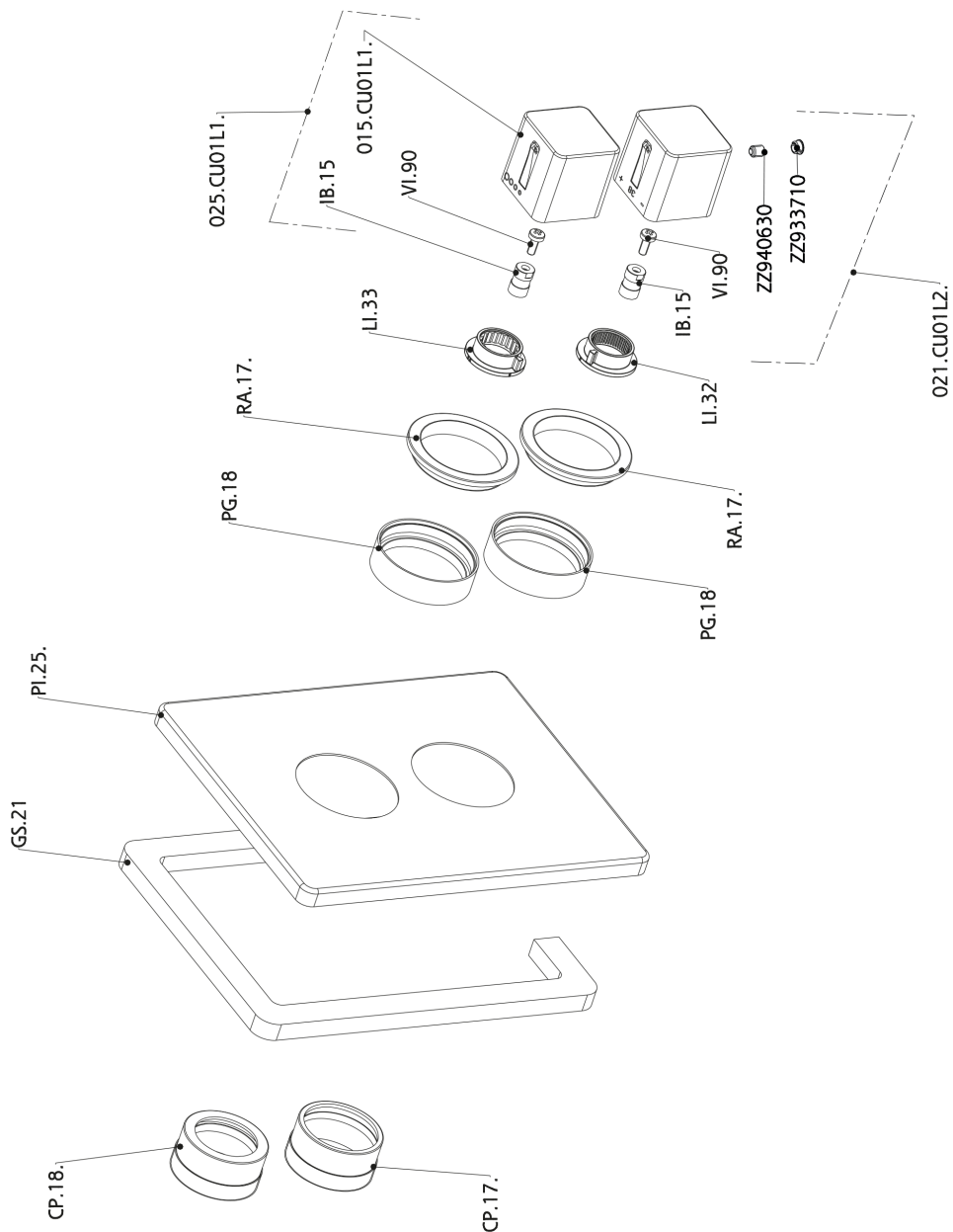

CU007300

<https://www.cisal.it/parte-esterna-termostatico-doccia-incasso-1-uscita-cubic-cu007300>

Parte incasso termostatico doccia 1 uscita INCASSO_ZA007301

MODELLO **ZA007301**

Parte incasso termostatico doccia 1 uscita, rubinetto d'arresto con uscita 1/2", senza parte esterna



FINITURE DISPONIBILI



04 04 Senza Finitura

CARATTERISTICHE

Ricambio Cartuccia **24.04A.PP**

Incasso **1**

Cartuccia Termostatica Plus P 8X20



Piastra/Plate/Plaque/Platte/Placa

2-3mm: XX 25-40 YY 76-91

10mm: XX 16-31 YY 65-80



Termostatico

Il Termostatico Cisal è il tuo personale gestore dell'acqua che ti aiuta a gestire e controllare acqua ed energia senza sprechi.



2026-06-19