

Parte esterna termostatico doccia incasso 1 uscita CUBIC_CU007300

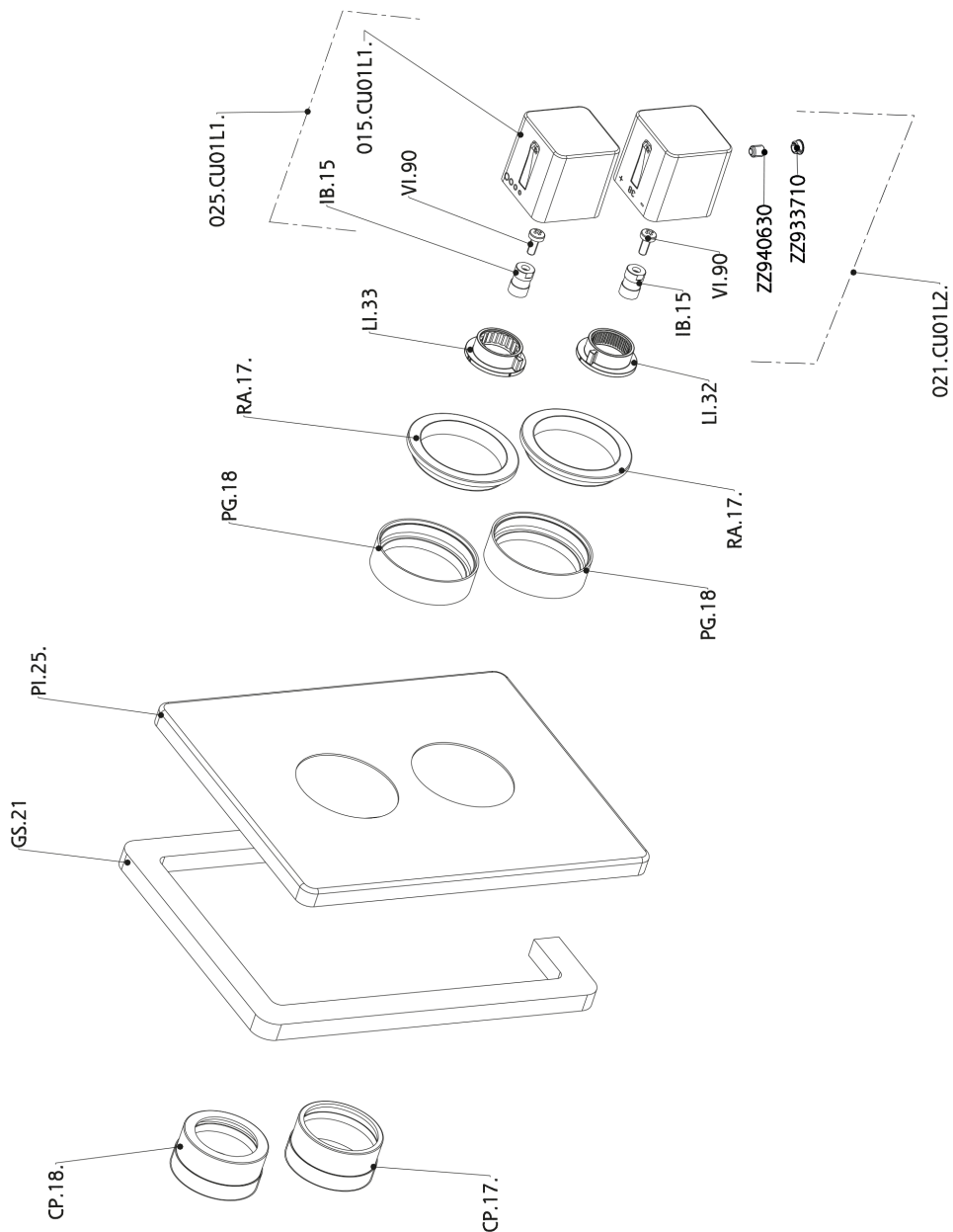

CU007300

<https://www.cisal.it/parte-esterna-termostatico-doccia-incasso-1-uscita-cubic-cu007300>

Parte incasso termostatico doccia 1 uscita INCASSO_ZA007301

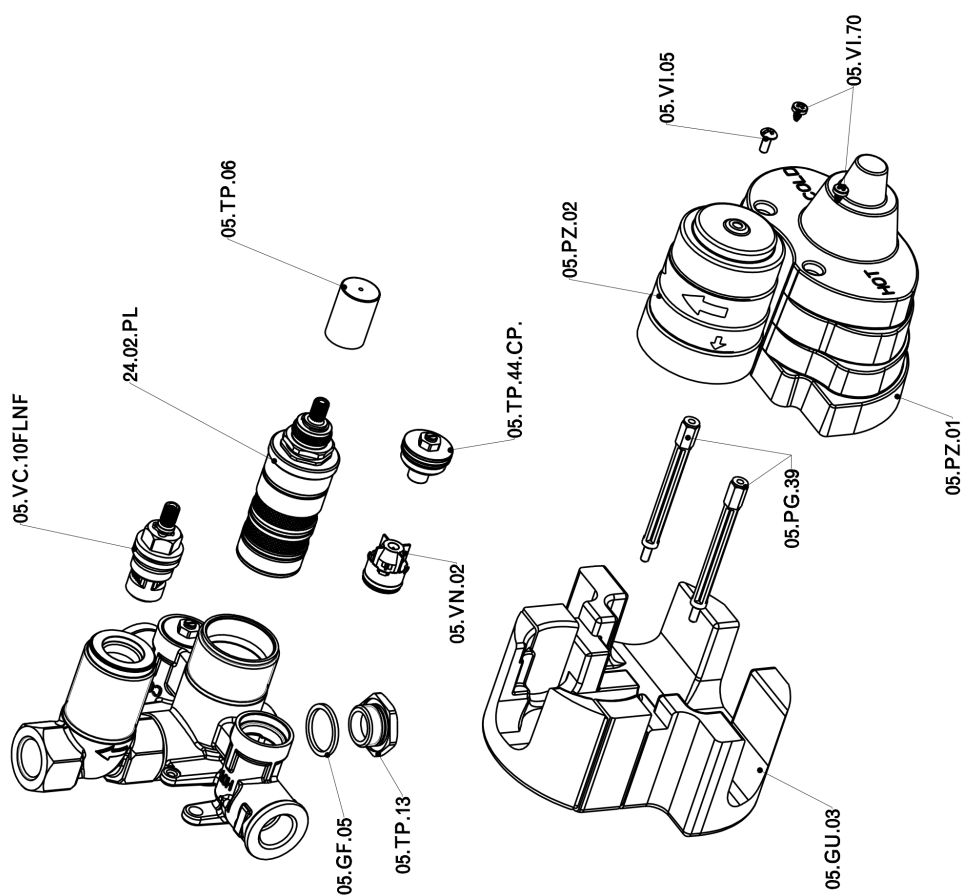

ZA007301

<https://www.cisal.it/parte-incasso-termostatico-doccia-1-uscita-incasso-za007301>

2026-05-01