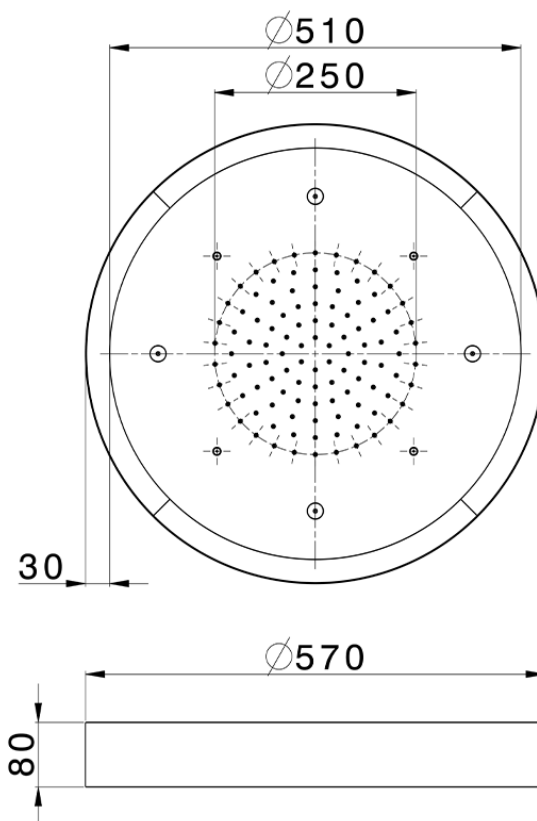

Soffione a soffitto con cromoterapia Ø 570 mm WELLNESS_ZS0C0170

ZS0C0170

<https://www.cisal.it/soffione-a-soffitto-con-cromoterapia-o-570-mm-wellness-zs0c0170>

2026-05-13