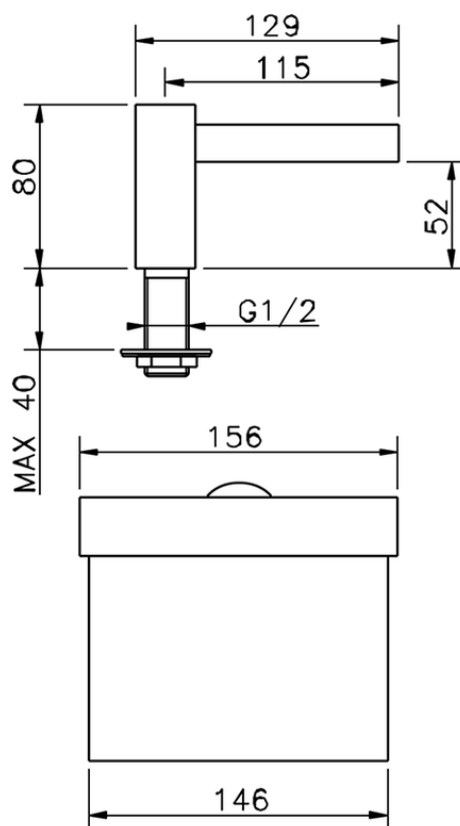

Bocca di erogazione COMPLEMENTI_ZA002620

ZA002620

<https://www.cisal.it/bocca-di-erogazione-complementi-za002620>

2026-06-23