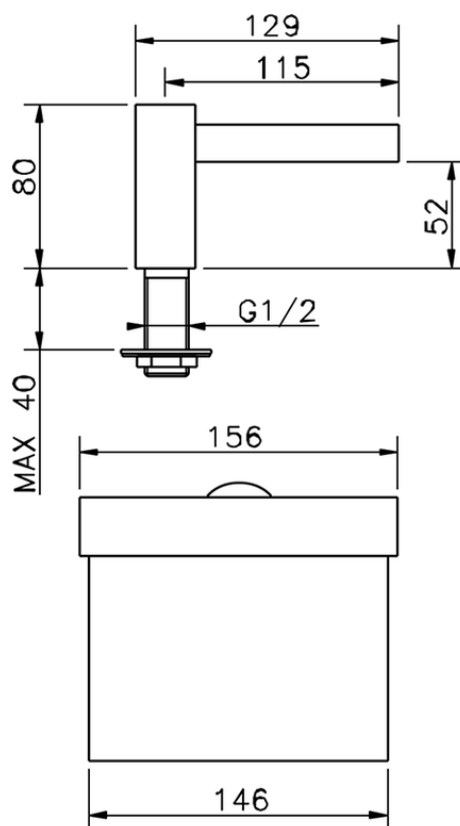

**Bocca di erogazione COMPLEMENTI\_ZA002620**

ZA002620

<https://www.cisal.it/bocca-di-erogazione-complementi-za002620>

2026-05-25