

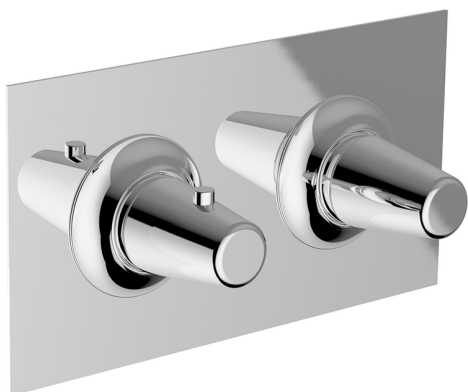



## Parte esterna termostatico doccia incasso 2 uscite VITA\_VI019140



MODELLO **VI019140**

Parte esterna termostatico doccia incasso 2 uscite, con deviasp 2 uscite, senza parte incasso, per art. ZA019140

### FINITURE DISPONIBILI

-  **21** 21 Cromo
-  **2Q** 2Q Black Titanium
-  **40** 40 Nero Opaco
-  **4Q** 4Q Bianco Opaco

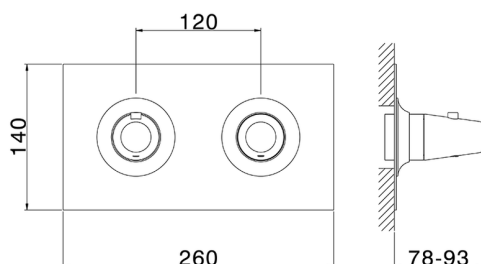

### CARATTERISTICHE

Installazione **Incasso**  
Parti Incasso necessarie **ZA019140**



### Termostatico

Il Termostatico Cisal è il tuo personale gestore dell'acqua che ti aiuta a gestire e controllare acqua ed energia senza sprechi.





## Parte incasso termostatico doccia 2 uscite INCASSO\_ZA019140

MODELLO **ZA019140**

Parte incasso termostatico doccia 2 uscite, senza parte esterna



FINITURE DISPONIBILI

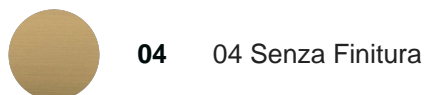

CARATTERISTICHE

Ricambio Cartuccia **24.04A.PP**

Incasso **1**

**Cartuccia Termostatica Plus P 8X20**

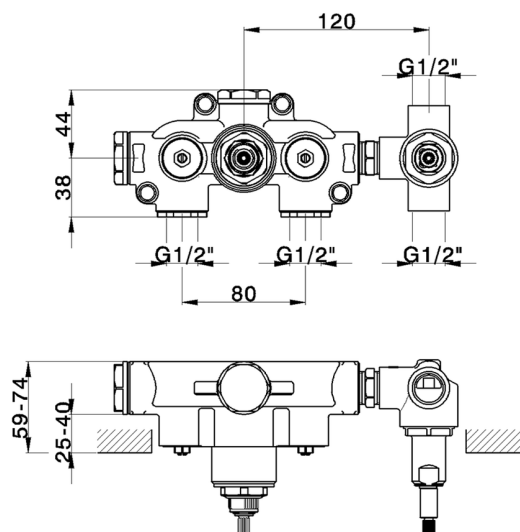

### Termostatico

Il Termostatico Cisal è il tuo personale gestore dell'acqua che ti aiuta a gestire e controllare acqua ed energia senza sprechi.



2026-06-19