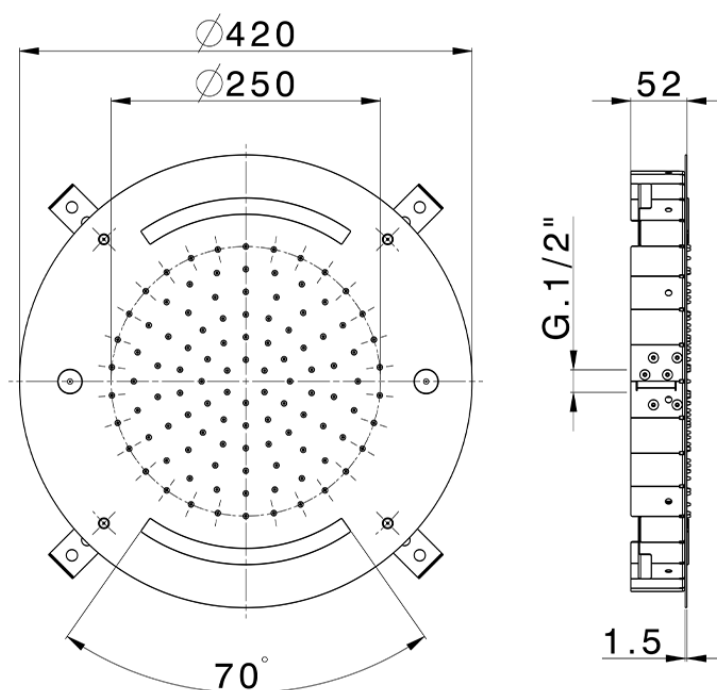

**Soffione a soffitto con cromoterapia Ø 420 mm WELLNESS\_ZS0C0025**

ZS0C0025

<https://www.cisal.it/soffione-a-soffitto-con-cromoterapia-o-420-mm-wellness-zs0c0025>

2026-06-27