

Parte esterna termostatico doccia incasso 3 uscite **CHERIE_CX019200**

MODELLO **CX019200**

Parte esterna termostatico doccia incasso 3 uscite, con deviasstop 3 uscite, senza parte incasso, per art. ZA019200



FINITURE DISPONIBILI

-  **6T** 6T Cromo/Nero Opaco
-  **7C** 7C Oro/Nero Opaco
-  **7D** 7D Nichel Lucido/Nero Opaco
-  **7E** 7E Oro Rosa/Nero Opaco

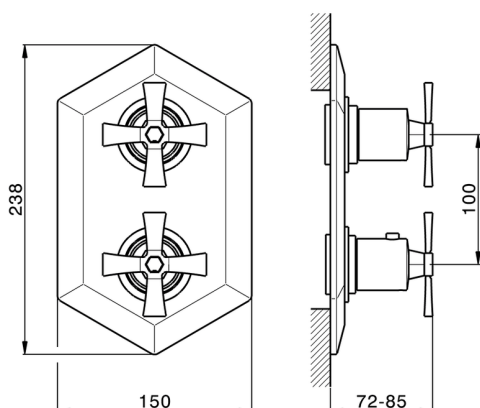

CARATTERISTICHE

Installazione **Incasso**
Parti Incasso necessarie **ZA019200**



Termostatico

Il Termostatico Cisal è il tuo personale gestore dell'acqua che ti aiuta a gestire e controllare acqua ed energia senza sprechi.



Parte incasso termostatico doccia 3 uscite INCASSO_ZA019200

MODELLO **ZA019200**

Parte incasso termostatico doccia 3 uscite, con deviastop 3 uscite 1/2", senza parte esterna

FINITURE DISPONIBILI

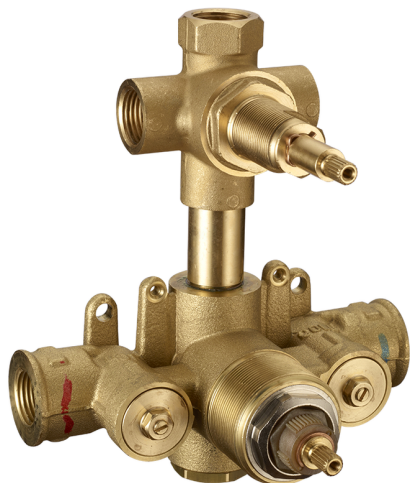
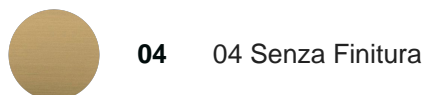

CARATTERISTICHE

Ricambio Cartuccia **24.04A.PP**

Incasso **1**

Cartuccia Termostatica Plus P 8X20

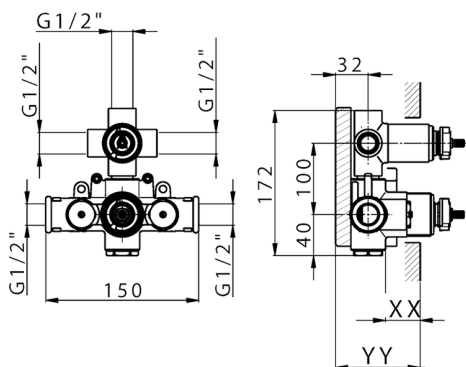

Piastra/Plate/Plaque/Platte/Placa

2-3mm: XX 25-40 YY 76-91

10mm: XX 21-34 YY 70-83



DeviaStop

La tecnologia Devia Stop di Cisal consente con un semplice movimento rotativo di gestire la portata dell'acqua e di scegliere la modalità d'erogazione (soffione, doccia a mano).



Termostatico

Il Termostatico Cisal è il tuo personale gestore dell'acqua che ti aiuta a gestire e controllare acqua ed energia senza sprechi.



2026-04-28