

Parte esterna termo doccia incasso 2 funzioni WELLNESS_VI01R200

MODELLO **VI01R200**

Parte esterna termo doccia incasso 2 funzioni, per art.ZA01R200

FINITURE DISPONIBILI

-  **21** 21 Cromo
-  **2Q** 2Q Black Titanium
-  **40** 40 Nero Opaco
-  **4Q** 4Q Bianco Opaco

CARATTERISTICHE

Installazione **Incasso**
 Parti Incasso necessarie **ZA01R200**

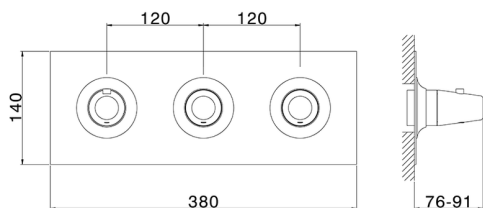

Termostatico

Il Termostatico Cisal è il tuo personale gestore dell'acqua che ti aiuta a gestire e controllare acqua ed energia senza sprechi.



Parte esterna termo doccia incasso 2 funzioni WELLNESS_VI01R200

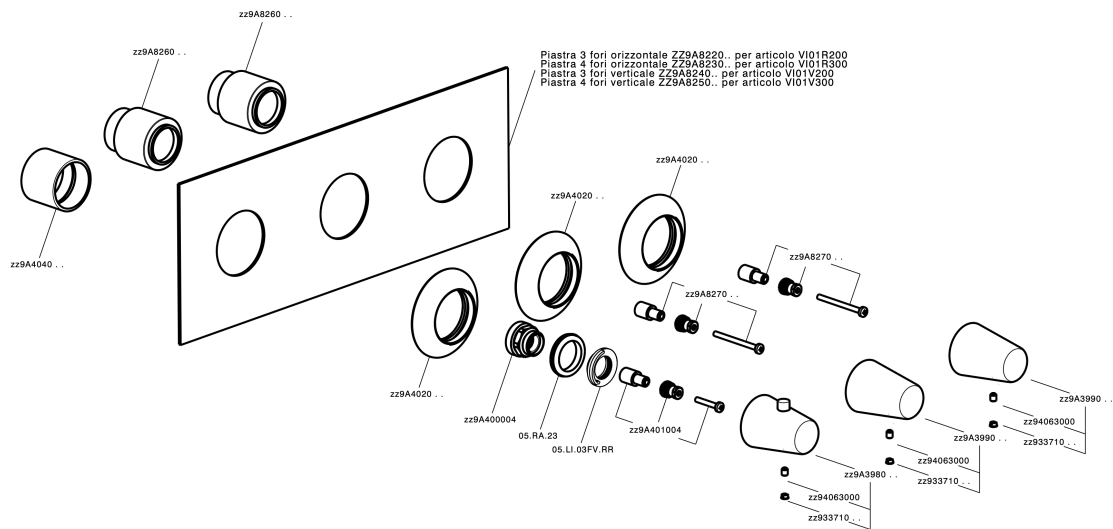

VI01R200

<https://www.cisal.it/parte-esterna-termo-doccia-incasso-2-funzioni-wellness-vi01r200>

Parte incasso termostatico 2 funzioni INCASSO_ZA01R200

MODELLO **ZA01R200**

Parte incasso termostatico 2 funzioni

FINITURE DISPONIBILI



04 04 Senza Finitura

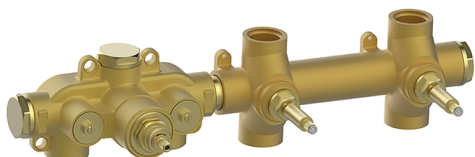

CARATTERISTICHE

Ricambio Cartuccia **23.51A.HF**

Incasso **1**

Cartuccia Termostatica HF

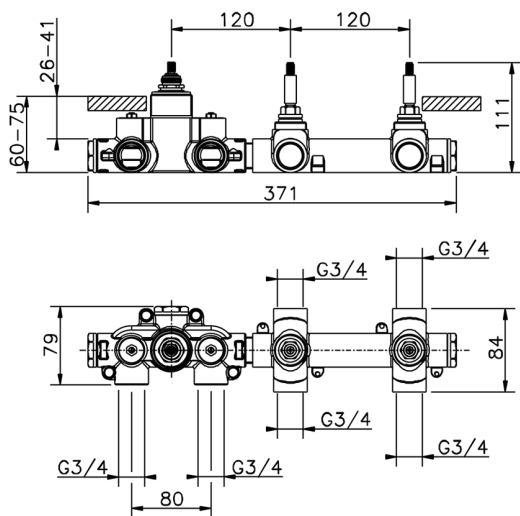

Termostatico

Il Termostatico Cisal è il tuo personale gestore dell'acqua che ti aiuta a gestire e controllare acqua ed energia senza sprechi.



2026-05-25