



Parte esterna lavabo a parete HI-RISE_RI013511

MODELLO **RI013511**

Parte esterna lavabo a parete, senza parte incasso, per art. ZA033510

FINITURE DISPONIBILI

-  **21** 21 Cromo
-  **24** 24 Oro
-  **2F** 2F Nichel Spazzolato
-  **2W** 2W Oro Spazzolato
-  **40** 40 Nero Opaco
-  **4Q** 4Q Bianco Opaco
-  **5G** 5G Oro Rosa
-  **6V** 6V Bianco Opaco/Nichel Spazzolato
-  **6X** 6X Bianco Opaco/Oro Spazzolato
-  **7W** 7W Nero Opaco/Oro Spazzolato

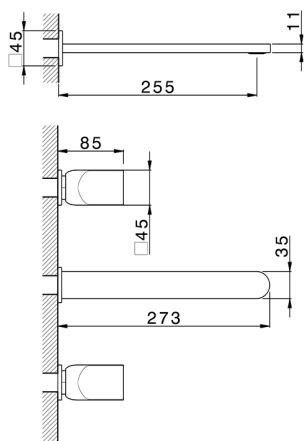
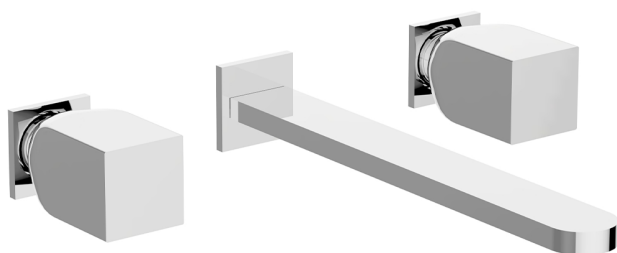

CARATTERISTICHE

Installazione **Incasso**
 Parti Incasso necessarie **ZA033510**



Parte incasso lavabo a parete INCASSO_ZA033510

MODELLO **ZA033510**

Parte incasso lavabo a parete, con due vitoni destri

FINITURE DISPONIBILI

 **04** 04 Senza Finitura

CARATTERISTICHE

Incasso **1**

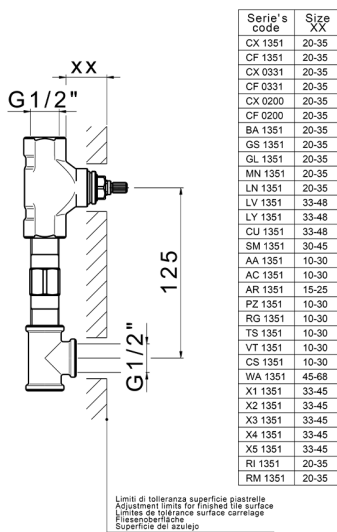

2026-06-30