



## Parte esterna lavabo a parete HI-RISE\_RI013511

MODELLO **RI013511**

Parte esterna lavabo a parete, senza parte incasso, per art. ZA033510

### FINITURE DISPONIBILI

- 
**21** 21 Cromo
- 
**24** 24 Oro
- 
**2F** 2F Nichel Spazzolato
- 
**2W** 2W Oro Spazzolato
- 
**40** 40 Nero Opaco
- 
**4Q** 4Q Bianco Opaco
- 
**5G** 5G Oro Rosa
- 
**6V** 6V Bianco Opaco/Nichel Spazzolato
- 
**6X** 6X Bianco Opaco/Oro Spazzolato
- 
**7W** 7W Nero Opaco/Oro Spazzolato

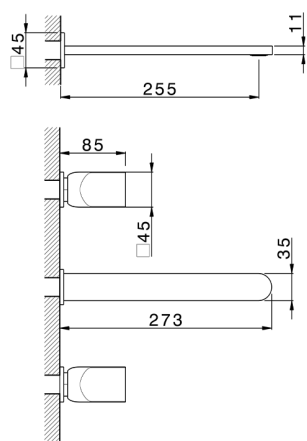
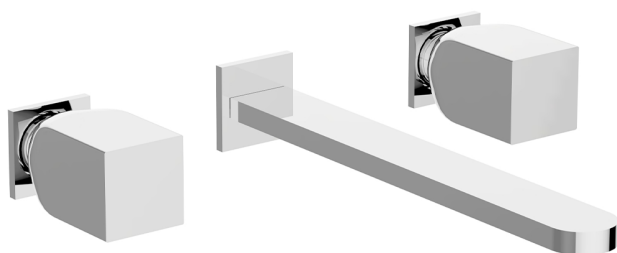

### CARATTERISTICHE

Installazione **Incasso**  
 Parti Incasso necessarie **ZA033510**



## Parte incasso lavabo a parete INCASSO\_ZA033510

MODELLO **ZA033510**

Parte incasso lavabo a parete, con due vitoni destri

FINITURE DISPONIBILI

 **04** 04 Senza Finitura

CARATTERISTICHE

Incasso **1**



2026-05-02