

## Miscelatore monocomando lavabo SLIM\_SM000730



MODELLO **SM000730**

Miscelatore monocomando lavabo, senza scarico automatico, flex inox G.3/8"

### FINITURE DISPONIBILI

-  **40** 40 Nero Opaco
-  **4Q** 4Q Bianco Opaco
-  **6T** 6T Cromo/Nero Opaco
-  **7D** 7D Nichel Lucido/Nero Opaco

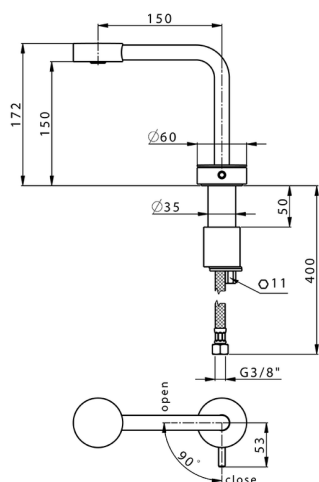

### CARATTERISTICHE

Ricambio Cartuccia **ZZ99856004**

**Cartuccia Monocomando progressiva 27mm**

Parti Incasso necessarie **ZA007301**



## Miscelatore monocomando lavabo SLIM\_SM000730

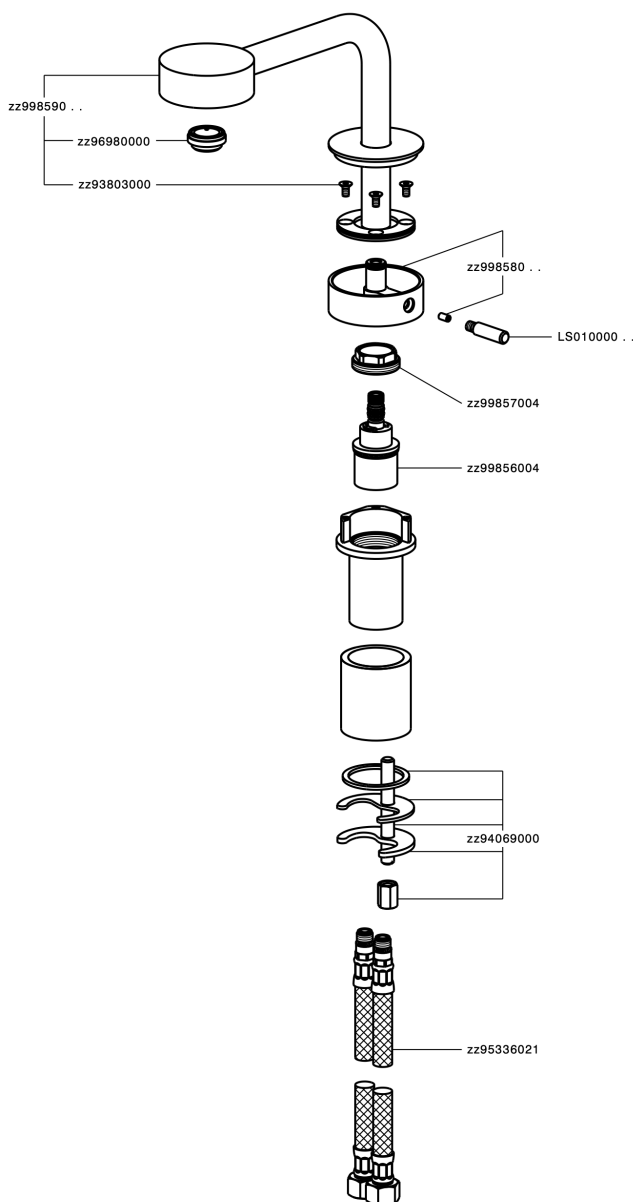

SM000730

<https://www.cisal.it/miscelatore-monocomando-lavabo-slim-sm000730>

## Parte incasso termostatico doccia 1 uscita INCASSO\_ZA007301

MODELLO **ZA007301**

Parte incasso termostatico doccia 1 uscita, rubinetto d'arresto con uscita 1/2", senza parte esterna

FINITURE DISPONIBILI



**04** 04 Senza Finitura



CARATTERISTICHE

Ricambio Cartuccia **24.04A.PP**

Incasso **1**

**Cartuccia Termostatica Plus P 8X20**



Piastra/Plate/Plaque/Platte/Placa

2-3mm: XX 25-40 YY 76-91

10mm: XX 16-31 YY 65-80



### Termostatico

Il Termostatico Cisal è il tuo personale gestore dell'acqua che ti aiuta a gestire e controllare acqua ed energia senza sprechi.



2026-05-03