

## Completo Termostatico per One-Box ARCANA CERAMIC\_AC0BT030

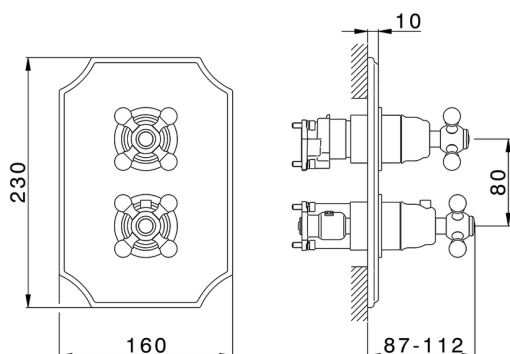
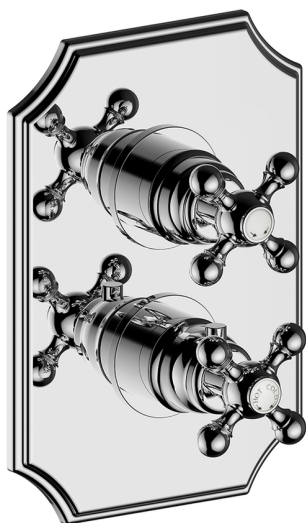

MODELLO **AC0BT030**

Completo Termostatico per One-Box, con deviasstop 1-2-3 uscite, profondità minima di installazione 67 mm, senza parte incasso, per art. ZA00B030-ZA00B031

### FINITURE DISPONIBILI

-  **21** 21 Cromo
-  **24** 24 Oro
-  **26** 26 Vecchio Rame
-  **27** 27 Vecchio Bronzo
-  **2A** 2A Nichel Satinato Spazzolato
-  **74** 74 Cromo/Oro

### CARATTERISTICHE

Ricambio Cartuccia **24.04A.PP**

**Cartuccia Termostatica Plus P 8X20**

Installazione **Incasso**

Parti Incasso necessarie **ZA00B031**

**ZA00B030**



### Termostatico

Il Termostatico Cisal è il tuo personale gestore dell'acqua che ti aiuta a gestire e controllare acqua ed energia senza sprechi.



## Completo Termostatico per One-Box ARCANA CERAMIC\_AC0BT030

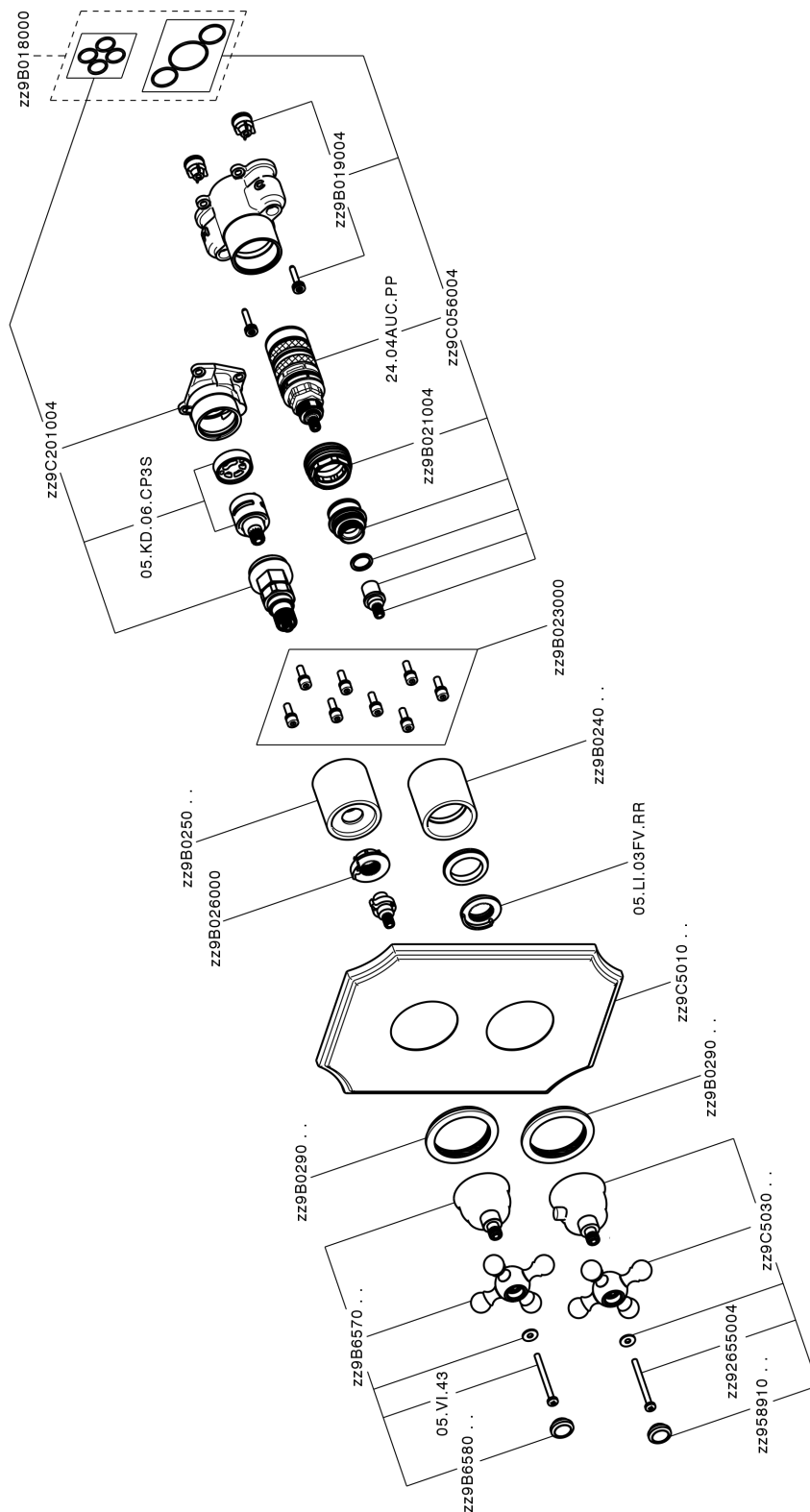

AC0BT030

<https://www.cisal.it/completo-termostatico-per-one-box-arcana-ceramic-ac0bt030>

## One-Box Universale per incasso ONE BOX\_ZA00B031

MODELLO **ZA00B031**

One-Box Universale per incasso, per termostatico o monocomando 1, 2 o 3 uscite, senza parte esterna, con silenziosi, con guarnizione per sigillatura

FINITURE DISPONIBILI

 **04** 04 Senza Finitura

CARATTERISTICHE

Incasso **1**



### Termostatico

Il Termostatico Cisal è il tuo personale gestore dell'acqua che ti aiuta a gestire e controllare acqua ed energia senza sprechi.



## One-Box Universale per incasso ONE BOX\_ZA00B030

MODELLO **ZA00B030**

One-Box Universale per incasso, per termostatico o monocomando 1, 2 o 3 uscite, senza parte esterna, senza silenziosi, con guarnizione per sigillatura

FINITURE DISPONIBILI

 **04** 04 Senza Finitura

CARATTERISTICHE

Incasso **1**



### Termostatico

Il Termostatico Cisal è il tuo personale gestore dell'acqua che ti aiuta a gestire e controllare acqua ed energia senza sprechi.



2026-04-30