





Parte esterna monocomando doccia incasso SLIM_SM003000

MODELLO **SM003000**

Parte esterna monocomando doccia incasso, senza parte incasso, per art. ZA005300



FINITURE DISPONIBILI

-  **21** 21 Cromo
-  **2B** 2B Nichel Lucido
-  **40** 40 Nero Opaco
-  **4Q** 4Q Bianco Opaco

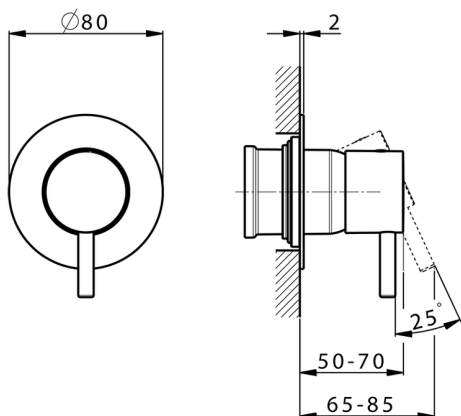

CARATTERISTICHE

Installazione **Incasso**
 Parti Incasso necessarie **ZA005300**



Parte esterna monocomando doccia incasso SLIM_SM003000

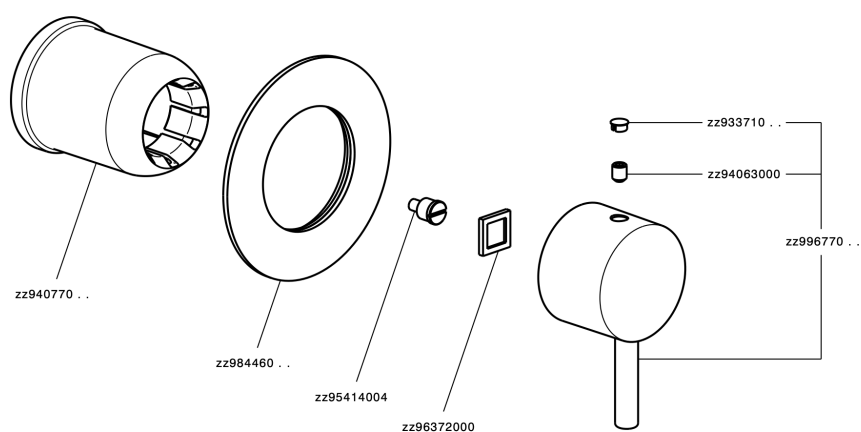

SM003000

<https://www.cisal.it/parte-esterna-monocomando-doccia-incasso-slim-sm003000>

Parte incasso monocomando doccia INCASSO_ZA005300

MODELLO **ZA005300**

Parte incasso monocomando doccia, doccia incasso
1/2", senza parte esterna



FINITURE DISPONIBILI



04 04 Senza Finitura

CARATTERISTICHE

Ricambio Cartuccia **ZZ94035000**

Incasso **1**

Cartuccia Monocomando 35 mm

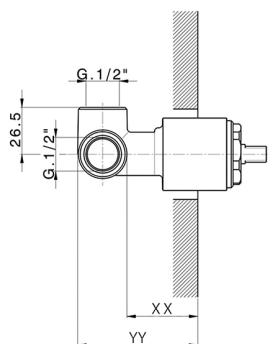

Piastra/Plate/Plaque/Platte/Placa
2-3mm: XX 27-47 YY 54-74
10mm: XX 16-40 YY 43-68



2026-05-05