

Parte incasso termostatico doccia 1 uscita INCASSO_ZA007301

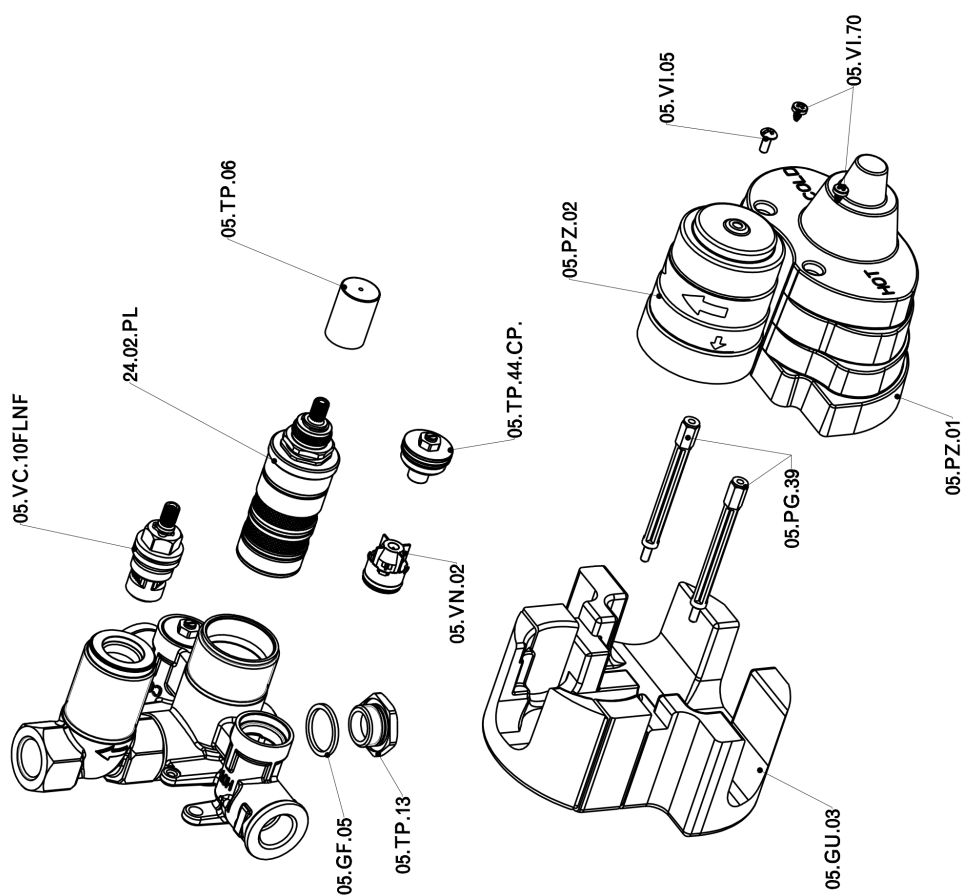

ZA007301

<https://www.cisal.it/parte-incasso-termostatico-doccia-1-uscita-incasso-za007301>

2026-06-19