

Parte esterna termostatico doccia incasso 1 uscita NUANCE X32_X1007300

MODELLO **X1007300**

Parte esterna termostatico doccia incasso 1 uscita, rubinetto d'arresto, senza parte incasso, per art. ZA007301, Inox AISI 316L

FINITURE DISPONIBILI

-  **D1** D1 Inox Spazzolato
-  **5H** 5H Dark Brass Brushed
-  **5L** 5L Black Titanium Spazzolato
-  **5N** 5N Oro Rosa Spazzolato

CARATTERISTICHE

Installazione **Incasso**
Parti Incasso necessarie **ZA007301**

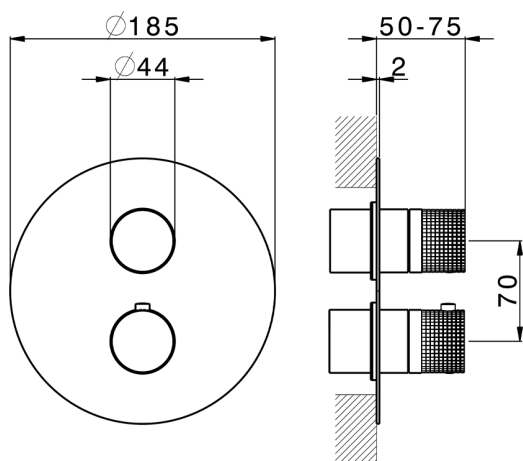
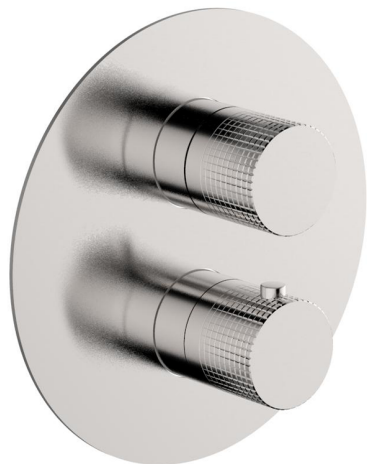

Termostatico

Il Termostatico Cisal è il tuo personale gestore dell'acqua che ti aiuta a gestire e controllare acqua ed energia senza sprechi.



Parte esterna termostatico doccia incasso 1 uscita NUANCE X32_X1007300

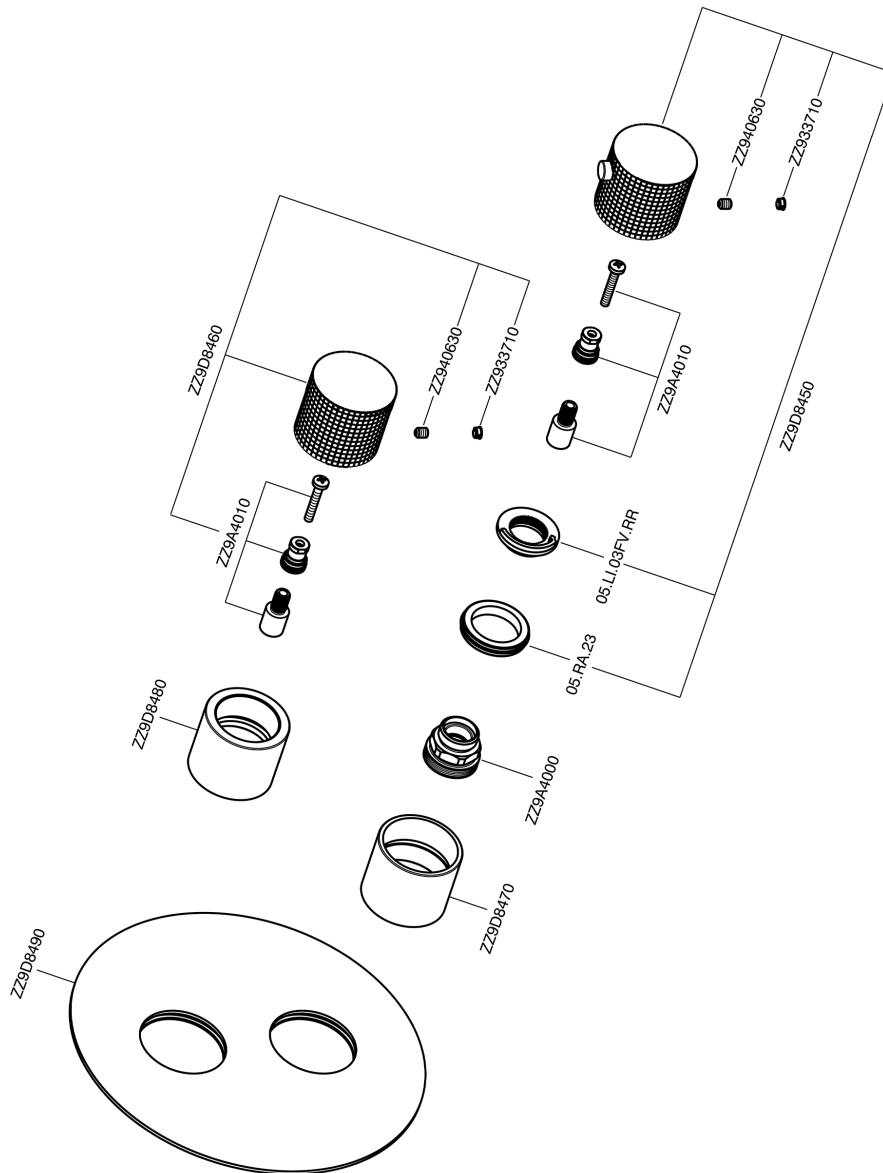

X1007300

<https://www.cisal.it/parte-esterna-termostatico-doccia-incasso-1-uscita-nuance-x32-x1007300>

Parte incasso termostatico doccia 1 uscita INCASSO_ZA007301

MODELLO **ZA007301**

Parte incasso termostatico doccia 1 uscita, rubinetto d'arresto con uscita 1/2", senza parte esterna

FINITURE DISPONIBILI



04 04 Senza Finitura



CARATTERISTICHE

Ricambio Cartuccia **24.04A.PP**

Incasso **1**

Cartuccia Termostatica Plus P 8X20



Piastra/Plate/Plaque/Platte/Placa

2-3mm: XX 25-40 YY 76-91

10mm: XX 16-31 YY 65-80



Termostatico

Il Termostatico Cisal è il tuo personale gestore dell'acqua che ti aiuta a gestire e controllare acqua ed energia senza sprechi.



2026-05-01