







## Parte esterna termo doccia incasso 2 funzioni WELLNESS\_RA01R200

MODELLO **RA01R200**

Parte esterna termo doccia incasso 2 funzioni, per art.ZA01R200

### FINITURE DISPONIBILI

-  **21** 21 Cromo
-  **2B** 2B Nichel Lucido
-  **2F** 2F Nichel Spazzolato
-  **2Q** 2Q Black Titanium
-  **40** 40 Nero Opaco
-  **4Q** 4Q Bianco Opaco

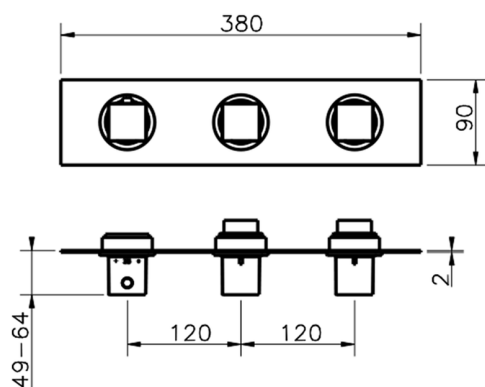
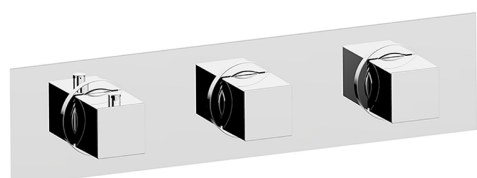

### CARATTERISTICHE

Installazione **Incasso**  
 Parti Incasso necessarie **ZA01R200**



### Termostatico

Il Termostatico Cisal è il tuo personale gestore dell'acqua che ti aiuta a gestire e controllare acqua ed energia senza sprechi.



## Parte incasso termostatico 2 funzioni INCASSO\_ZA01R200

MODELLO **ZA01R200**

Parte incasso termostatico 2 funzioni

FINITURE DISPONIBILI



**04** 04 Senza Finitura



CARATTERISTICHE

Ricambio Cartuccia **23.51A.HF**

Incasso **1**

**Cartuccia Termostatica HF**



### Termostatico

Il Termostatico Cisal è il tuo personale gestore dell'acqua che ti aiuta a gestire e controllare acqua ed energia senza sprechi.



2026-05-01